

Operating instructions Precision balances

KERN PNJ / PNS

Version 1.2
04/2016
GB



PNJ_PNS-BA-e-1612



KERN PNJ / PNS

Version 1.2 04/2016

Operating instructions Precision balance

Contents

1	Technical data	4
1.1	Dimensions	6
2	Appliance overview	7
2.1	Keyboard overview	8
2.2	Overview of display	9
3	Basic instructions	10
3.1	Intended use	10
3.2	Improper Use	10
3.3	Warranty	10
3.4	Monitoring of Test Resources.....	11
4	Basic Safety Precautions	11
4.1	Pay attention to the instructions in the Operation Manual.....	11
4.2	Personnel training.....	11
5	Transport and storage	11
5.1	Testing upon acceptance	11
5.2	Packaging / return transport	11
6	Unpacking, Setup and Commissioning	12
6.1	Installation Site, Location of Use	12
6.2	Unpacking, Scope of delivery	12
6.2.1	Scope of delivery / serial accessories:	13
6.3	Assemble windshield (only models d = 0.001g)	14
6.4	Assembly, placing and levelling	20
6.5	Mains connection.....	22
6.6	Initial Commissioning.....	23
6.6.1	Models PNJ	23
6.6.2	Models PNS.....	24
6.7	Connection of peripheral devices	24
6.8	Adjustment.....	25
6.8.1	Adjustment with internal weight (only models PNJ)	26
6.8.2	Adjustment with external weight (only models PNS).....	27
6.9	Verification	28
7	Basic Operation	30
7.1	Start-up	30
7.2	Switch into stand-by mode	30
7.3	Zeroing.....	31
7.4	Simple weighing	31
7.5	Unity change.....	32
7.6	Weighing with tare	34
7.6.1	Taring.....	34
7.6.2	Multiple tare	35

8	Menu	36
8.1	Menu [function]	36
8.1.1	Navigation in the menu	36
8.1.2	Menu overview	37
8.2	Menu [Function2]	40
8.2.1	Navigation in the menu	40
8.2.2	Menu overview	40
9	Applications	41
9.1	Parts counting	41
9.2	Percent determination	44
9.3	Weighing with tolerance range	46
9.3.1	Enable function / settings in menu	47
9.3.2	Tolerance check after setting the limit values by weighing	49
9.3.3	Tolerance check after numeric input of the limit values	51
10	General functions	53
10.1	Zero-tracking	53
10.2	Settings for Stability and Response	54
10.3	Show software status (only models PNJ)	55
10.4	Switch-off background illumination of the display automatically (only models PNJ)	56
10.5	Setting date / time (only models PNJ)	57
10.5.1	Setting time	57
10.5.2	Setting date	59
10.6	Set date format (only models PNJ)	61
11	RS232C-interface	62
11.1	General hints	62
11.2	Printer operation	65
11.2.1	Edit an ISO/GLP/GMP-conform adjustment log (only models PNJ)	65
11.2.2	Protocol output with current date / time (only models PNJ)	66
11.3	Data output	68
11.3.1	Data transmission format	68
11.3.2	Description of data	70
11.3.3	Output examples	72
11.4	Remote control instructions	73
12	Servicing, maintenance, disposal	75
12.1	Cleaning	75
12.2	Servicing, maintenance	75
12.3	Disposal	75
13	Instant help	76
14	Error messages	77
15	Declaration of conformity	78

1 Technical data

KERN	PNJ 600-3M	PNJ 3000-2M	PNJ 12000-1M
Weighing range (max)	620 g	3200 g	12000 g
Readability (d)	0.001 g	0.01 g	0.1g
Minimum load (Min)	0.2 g	0.5 g	5 g
Verification value (e)	0.01 g	0.1g	1 g
Verification class	I	II	II
Reproducibility	0.001 g	0.01 g	0.1 g
Linearity	± 0.004 g	± 0.02 g	± 0.2 g
Smallest part weight for piece counting	0.001g	0.01 g	0.1 g
Reference quantities at piece counting	10, 30, 50, 100		
Adjustment weight	internal		
Weighing Units	g, ct		
Adjustment	internal		
Warm-up time	4 h	2 h	
Stabilization time (typical)	3 s		
Operating temperature	+ 5° C + 40° C		
Humidity of air	max. 80 % (not condensing)		
Weight kg (net)	4200 g	3500 g	
Electric power supply	Line adapter 220V-240V, 50 Hz Balance 6 V, 1 A		
Interface	RS232		

KERN	PNS 600-3	PNS 3000-2	PNS 12000-1
Weighing range (max)	620 g	3200 g	12000 g
Readability (d)	0.001 g	0.01 g	0.1 g
Reproducibility	0.001 g	0.01g	0.1 g
Linearity	± 0.004 g	± 0.02 g	± 0.2 g
Recommended adjustment weight, not added (class)	600 g (F1)	3 kg (F1)	12 kg (F1)
Smallest part weight for piece counting	0.001g	0.01 g	0.1 g
Reference quantities at piece counting	10, 30, 50, 100		
Weighing Units	g, ct, dwt, lb, mo, oz, ozt, tl (HK), tl (Singap., Malays), tl (Tw), tol		
Warm-up time	4 h	2 h	
Stabilization time (typical)	3 s		
Operating temperature	+ 5° C + 40° C		
Humidity of air	max. 80 % (not condensing)		
Weight kg (net)	3500 g	2600 g	
Electric power supply	Line adapter 220V-240V, 50 Hz Balance 6 V, 1 A		
Interface	RS232		

1.1 Dimensions

Models d = 0.001g:

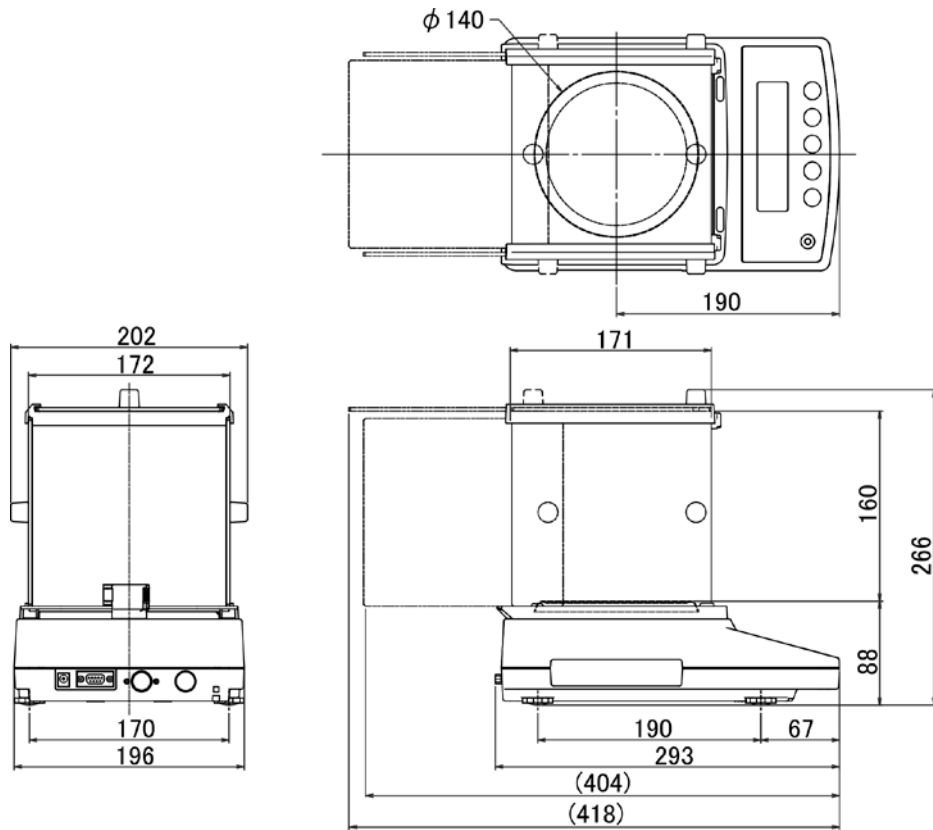

Models d = 0.01g / 0.1 g:

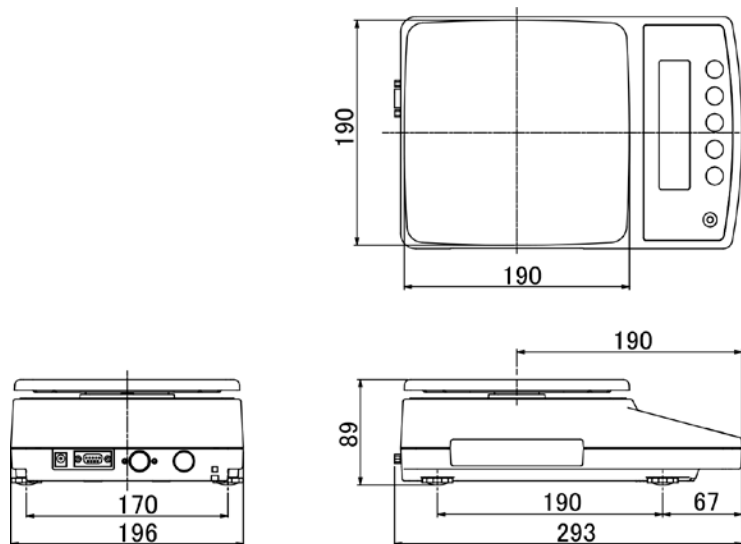

2 Appliance overview

Models $d = 0.001\text{g}$:

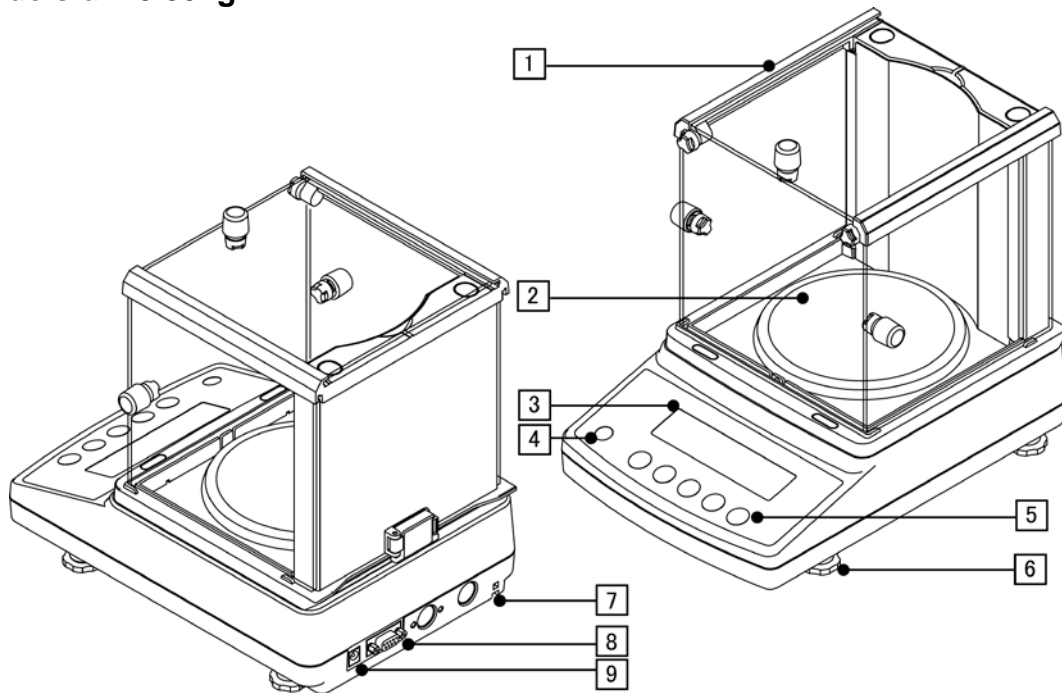



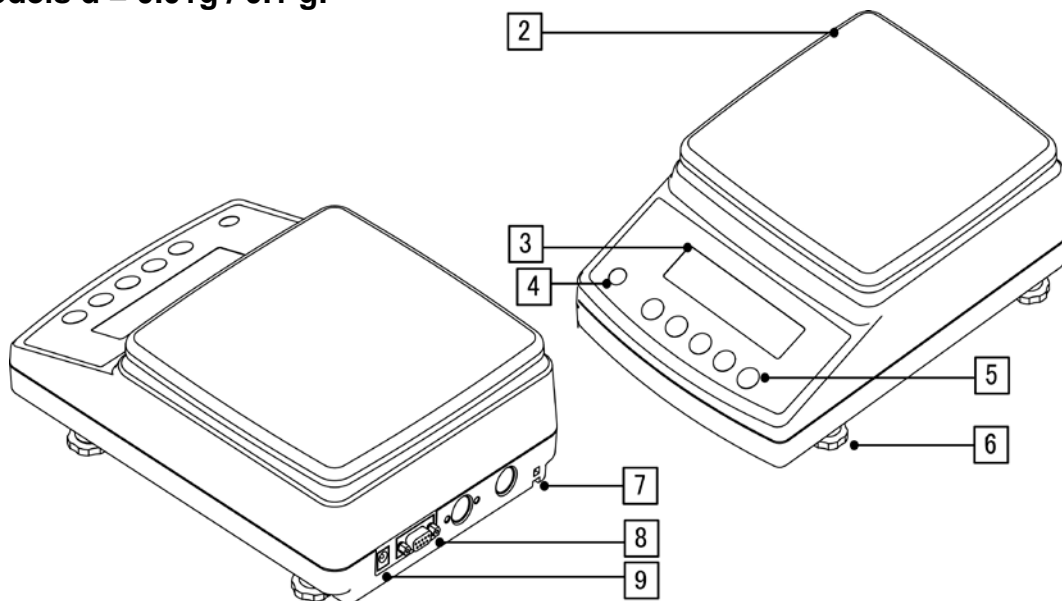



Models $d = 0.01\text{g} / 0.1\text{g}$:

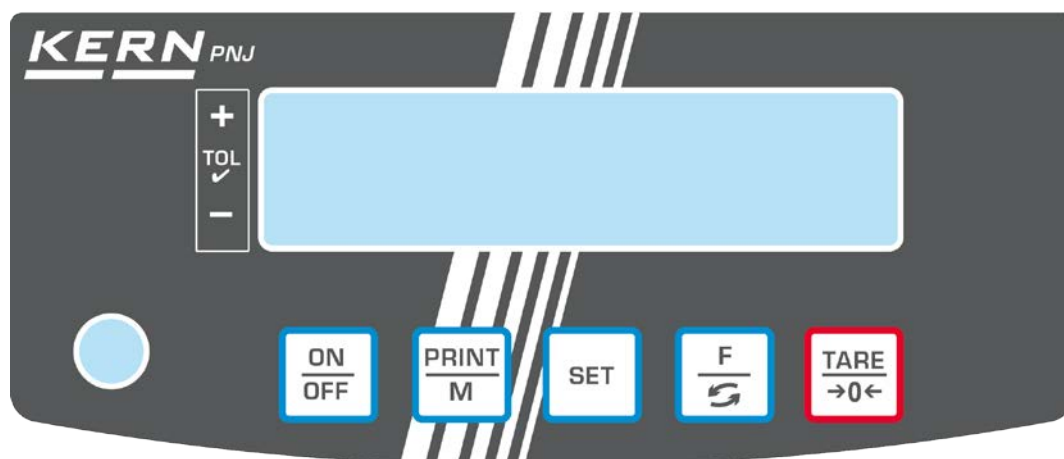

Pos.	Designation	Pos.	Designation
1	Windshield	6	Footscrews
2	Weighing pan	7	Fastening point for anti-theft protection
3	Display	8	Interface RS232
4	Bubble level	9	Terminal power supply unit
5	Operator keys		

2.1 Keyboard overview



Button	Function
	<ul style="list-style-type: none"> ➤ Turn on/off
	<ul style="list-style-type: none"> ➤ Transfer weighing data via interface ➤ Exit menu / back to weighing mode.
	<ul style="list-style-type: none"> ➤ Save settings/back to weighing mode
	<ul style="list-style-type: none"> ➤ Switch-over weighing unit ➤ Menu access (longer pressing of the button) ➤ Scroll forward in menu
	<ul style="list-style-type: none"> ➤ Taring ➤ Zeroing ➤ Change menu settings

2.2 Overview of display

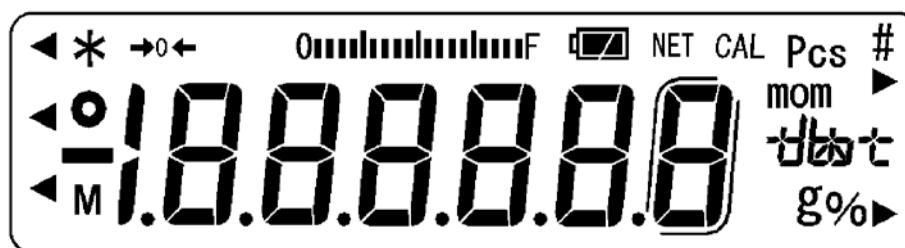

Display	Description
g	Weighing unit "gram"
→0←	Zero indicator
NET	Display net weight values
○	Display of stable values
*	The balance is in stand-by mode Illuminated during data transfer
Pcs	Application icon for piece counting
%	Application icon for percentage determination
◀	Tolerance mark during check weighing
(mom)	Weighing unit „Momme“
M	The balance processor is just processing a function.
CAL	Illuminates and flashes during an adjustment process
⌈	Brackets for identifying non verified digits (only verified models)
00000000 F	Capacity display The bar graph display moves from the left to the right and proceeds equally to the weight loaded onto the weighing balance. Its full width is reached at maximum load. This is an analogue display of the current allocation of the weighing area.
Units field tlt	[ct] (ct) Carat
	[oz] (oz) Ounze
	[lb] (lb) Pound
	[oz t] (ozt) Feinunze
	[dwt] (dwt) Penny weight
	[tl] (tl) Tael (Hong Kong)
	[tl ▶ upper right] (tl ▶ upper right) Tael (Singapore, Malaysia)
	[tl ▶ [lower right] (tl ▶ lower right) Tael (Taiwan)
	[to] (to) Tola

3 Basic instructions

3.1 Intended use

The balance you purchased is intended to determine the weighing value of material to be weighed. It is intended to be used as a “non-automatic balance”, i.e. the material to be weighed is manually and carefully placed in the centre of the weighing pan. As soon as a stable weighing value is reached the weighing value can be read.

3.2 Improper Use

Do not use balance for dynamic weighing. In the event that small quantities are removed or added to the material to be weighed, incorrect weighing results can be displayed due to the “stability compensation“. (Example: Slowly draining fluids from a container on the balance.)

Do not leave permanent load on the weighing pan. This may damage the measuring system.

Impacts and overloading exceeding the stated maximum load (max) of the balance, minus a possibly existing tare load, must be strictly avoided. Balance may be damaged by this.

Never operate balance in explosive environment. The serial version is not explosion protected.

The structure of the balance may not be modified. This may lead to incorrect weighing results, safety-related faults and destruction of the balance.

The balance may only be used according to the described conditions. Other areas of use must be released by KERN in writing.

3.3 Warranty

Warranty claims shall be voided in case

- Our conditions in the operation manual are ignored
- The appliance is used outside the described uses
- The appliance is modified or opened
- Mechanical damage and damage caused by media, liquids, natural wear and tear
- The appliance is improperly set up or incorrectly electrically connected
- The measuring system is overloaded

3.4 Monitoring of Test Resources

In the framework of quality assurance the measuring-related properties of the balance and, if applicable, the testing weight, must be checked regularly. The responsible user must define a suitable interval as well as type and scope of this test. Information is available on KERN's home page (www.kern-sohn.com) with regard to the monitoring of balance test substances and the test weights required for this. In KERN's accredited DKD calibration laboratory test weights and balances may be calibrated (return to the national standard) fast and at moderate cost.

4 Basic Safety Precautions

4.1 Pay attention to the instructions in the Operation Manual



Carefully read this operation manual before setup and commissioning, even if you are already familiar with KERN balances.

All language versions contain a non-binding translation. The original German is binding.

4.2 Personnel training

The appliance may only be operated and maintained by trained personnel.

5 Transport and storage

5.1 Testing upon acceptance

When receiving the appliance, please check packaging immediately, and the appliance itself when unpacking for possible visible damage.

5.2 Packaging / return transport



- ⇒ Keep all parts of the original packaging for a possibly required return.
- ⇒ Only use original packaging for returning.
- ⇒ Prior to dispatch disconnect all cables and remove loose/mobile parts.
- ⇒ Reattach possibly supplied transport securing devices.
- ⇒ Secure all parts such as the glass wind screen, the weighing pan, power unit etc. against shifting and damage.

6 Unpacking, Setup and Commissioning

6.1 Installation Site, Location of Use

The balances are designed in a way that reliable weighing results are achieved in common conditions of use.

You will work accurately and fast, if you select the right location for your balance.

Therefore, observe the following for the installation site:

- Place the balance on a firm, level surface.
- Avoid extreme heat as well as temperature fluctuation caused by installing next to a radiator or in the direct sunlight.
- Protect the balance against direct draughts due to open windows and doors.
- Avoid jarring during weighing.
- Protect the balance against high humidity, vapours and dust.
- Do not expose the device to extreme dampness for longer periods of time. Non-permitted condensation (condensation of air humidity on the appliance) may occur if a cold appliance is taken to a considerably warmer environment. In this case, acclimatize the disconnected appliance for ca. 2 hours at room temperature.
- Avoid static charge of goods to be weighed or weighing container.

Major display deviations (incorrect weighing results) may be experienced should electromagnetic fields (e.g. due to mobile phones or radio equipment), static electricity accumulations or instable power supply occur. Change location or remove source of interference.

6.2 Unpacking, Scope of delivery

Remove device and accessories carefully from packaging, remove packaging material and place device at the planned work place. Verify that there has been no damage and that all packing items are present.

6.2.1 Scope of delivery / serial accessories:

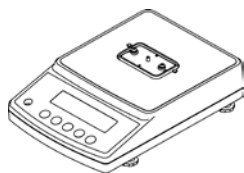

Balance

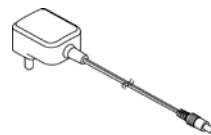

Net adapter and plug set



Round weighing pan
(models d = 0.001g)

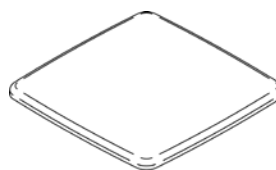

Angular weighing pan
(models d = 0.01g / 0.1 g)

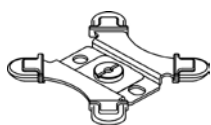

Carrier for round weighing pan
(models d = 0.001g)



Carrier for angular weighing pan
(models d = 0.01g / 0.1 g)

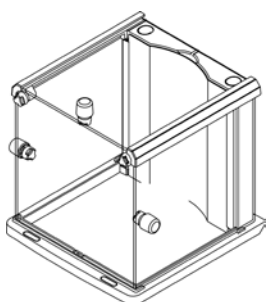







Windshield (models d = 0.001g)
Assembly see chap. 6.3

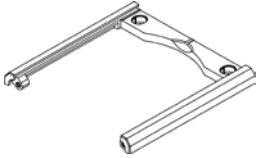
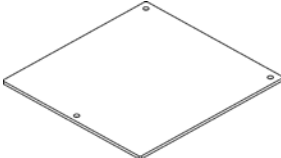
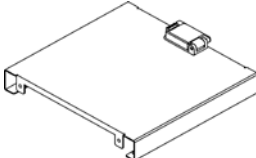
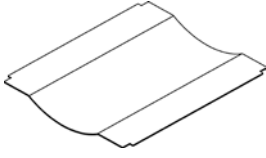
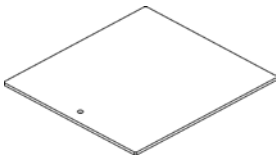

Operating instructions

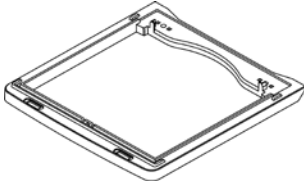
6.3 Assemble windshield (only models d = 0.001g)

Parts overview:

	Quantity		Quantity
Guide frame 	1	Front plate (with 3 bore holes) 	1
Rear wall 	1	Inner plate 	1
Side wall 	3	Handle 	3
		Fastening screw "Handle" 	5
Base frame 	1	Cover 	2
		Front cap 	2
Support inner plate 	2	M4 screws 	4

Assembly:

- 1 ⇒ Loosen locking system at the back panel

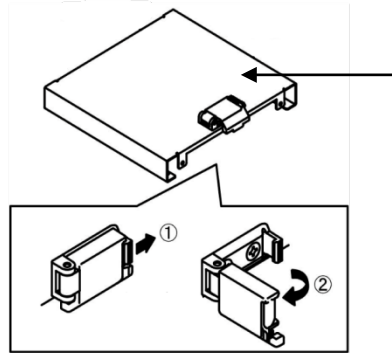

- 2 ⇒ Fix the back panel on the ground frame with two screws (M4)

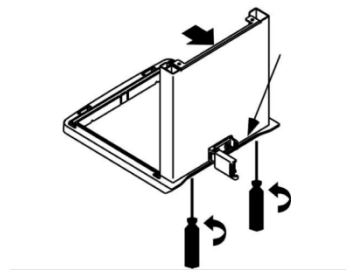

- 3 ⇒ Assemble the supports for the inner plate acc. to fig.

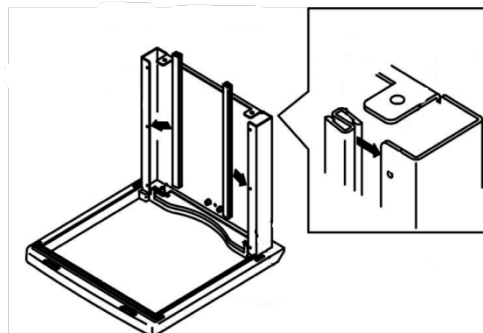

- 4 ⇒ Fasten the front plate.

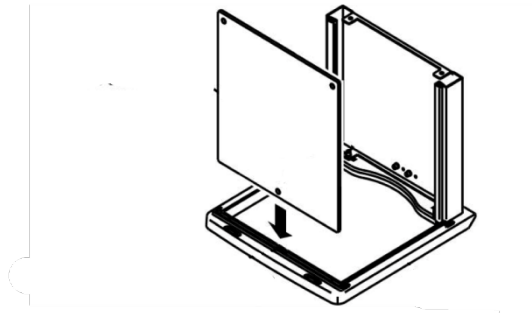

Make sure that the fastening point is placed at the frame in the bore hole of the front plate.

- 5 ⇒ Secure the front plate with the guide frame temporarily against falling out.

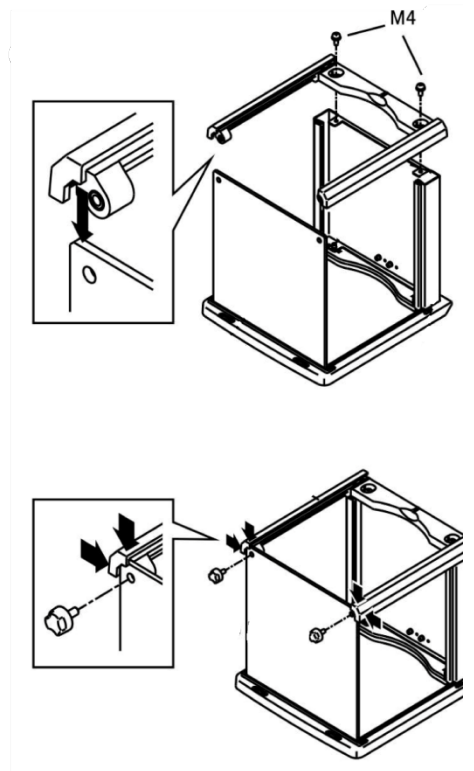

6

⇒ Push the side panels from the rear to the front into the guide frame. Make sure that the bore holes point towards the front plate.

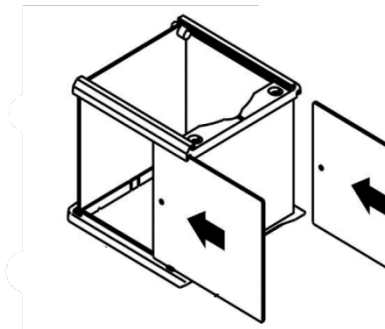

7

⇒ Fix the handles with the fastening screws.

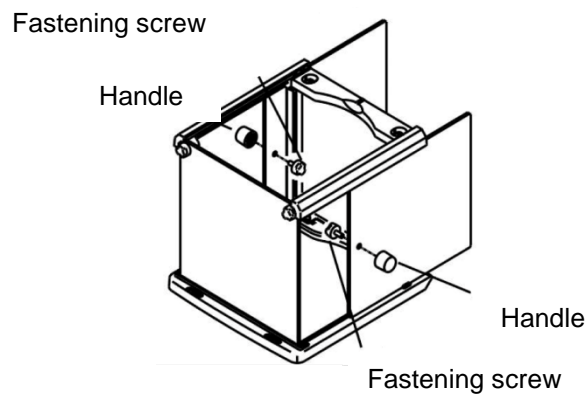

8

⇒ Fix the guide frame with two screws (M4).

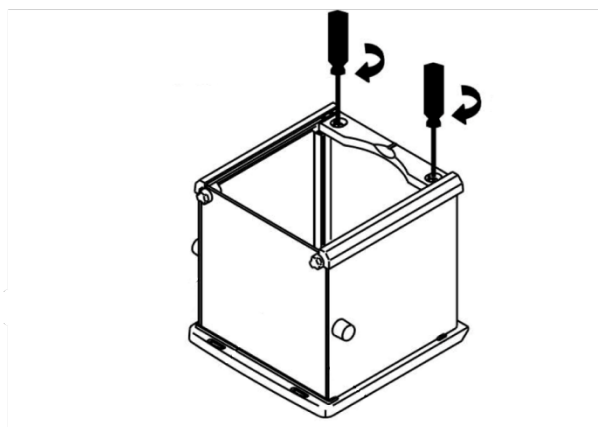

9

⇒ Attach the covers and the front caps

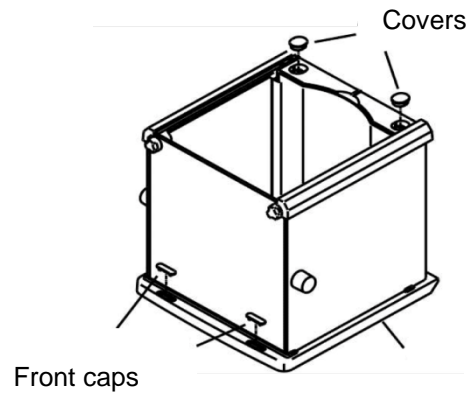

0

⇒ Install inner plate. For this purpose push the plate through the two supports.

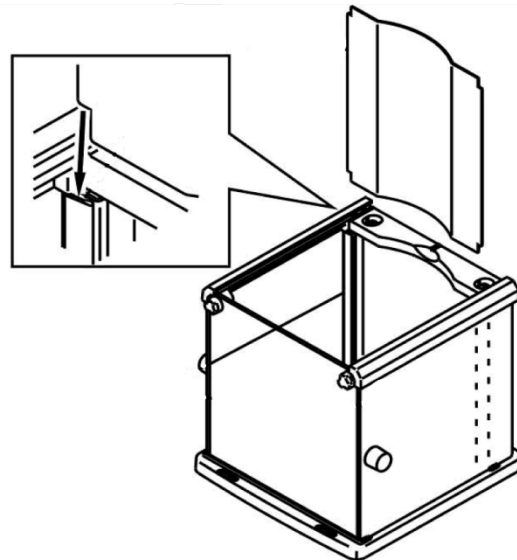

a

⇒ Attach the upper glass pane and fix the handles with the fastening screws.

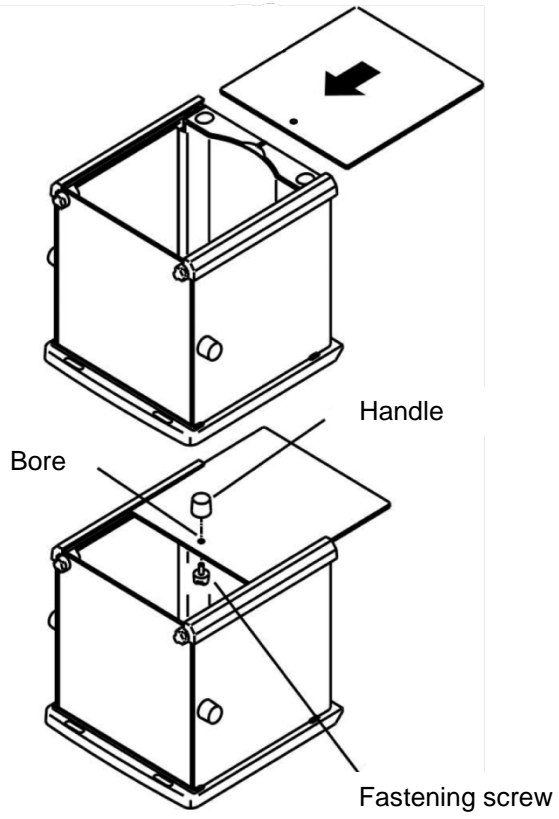

6.4 Assembly, placing and levelling

The right place is decisive for the accuracy of the weighing results of high-resolution precision balances (see chap. 6.1).

- ⇒ Place the weighing pan carrier acc. to fig. and fix it carefully e.g. with a coin.

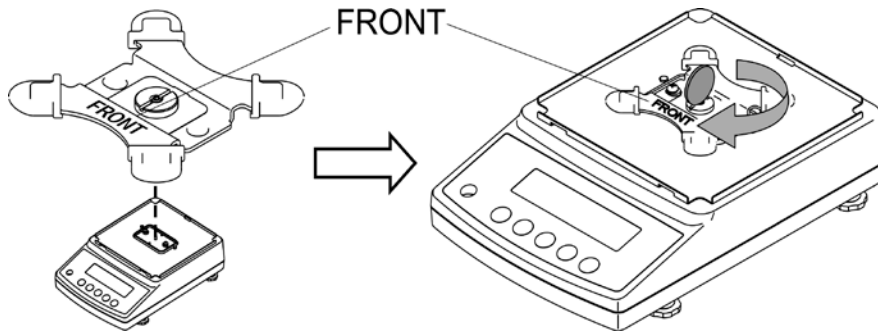

- ⇒ Place weighing pan

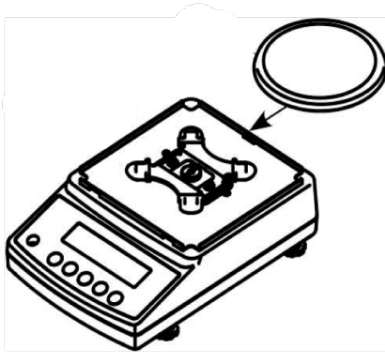

Models $d = 0.001\text{g}$

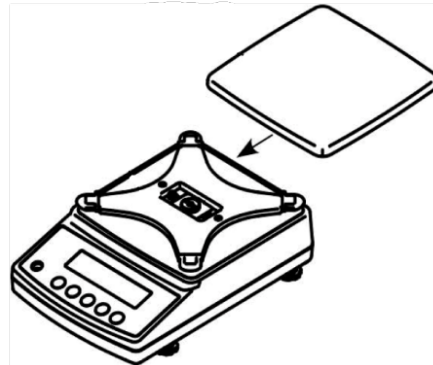

Models $d = 0.01\text{g} / 0.1\text{g}$

- ⇒ Install windshield (only models $d = 0.001\text{g}$).
Make sure that the locking system at the back panel is released.

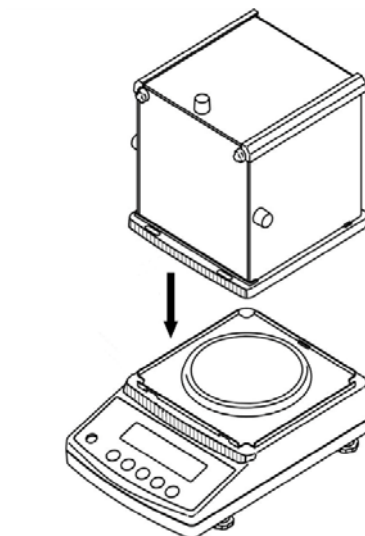

- ⇒ Place the windshield carefully on the balance and align.
- ⇒ For safeguarding close the locking system at the back panel.

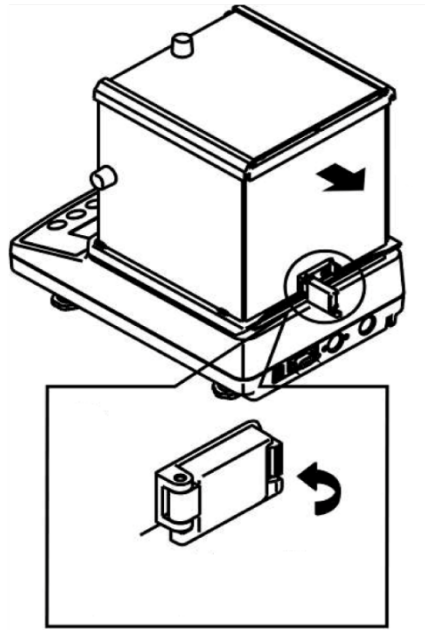

- ⇒ Level balance with foot screws until the air bubble of the water balance is in the prescribed circle.

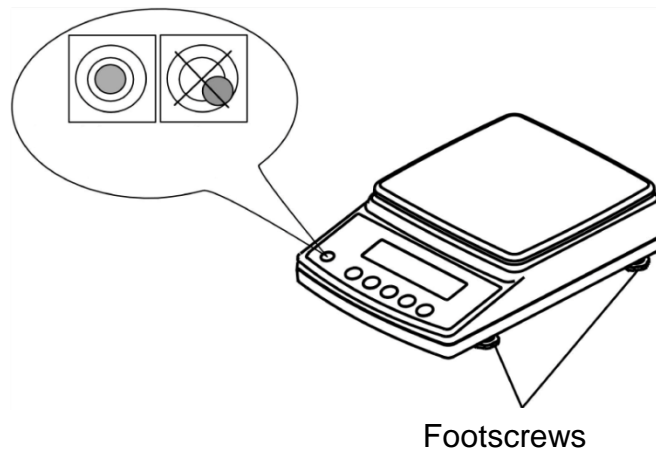

- ⇒ Check levelling regularly

6.5 Mains connection



Select a country-specific net plug and mount it on the mains adapter.



Check, whether the voltage acceptance on the scales is set correctly. Do not connect the scales to the power grid unless the information on the instrument (sticker) matches the local mains voltage.

Only use KERN original mains adapter. Using other makes requires consent by KERN.



Important:

Does the rating match the standard local mains current?

- Do not connect if mains voltages are different!
- If matching, connect the scales.

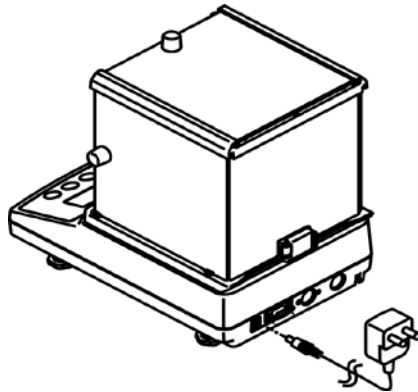

Models d = 0.001g

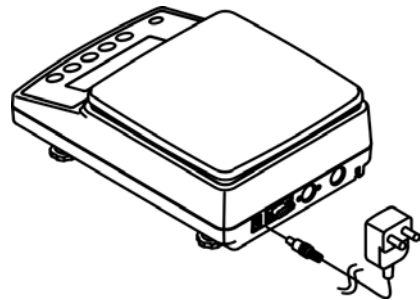

Models d = 0.01g / 0.1 g

As soon as the balance is supplied with energy, the indicator [*****] is displayed.



In order to obtain exact results with the electronic balances, your balance must have reached the operating temperature (see warming up time chap. 1). During this warming up time the balance must be connected to the power supply (mains, accumulator or battery).

The accuracy of the balance depends on the local acceleration of gravity. Strictly observe hints in chapter Adjustment.

6.6 Initial Commissioning

6.6.1 Models PNJ



As soon as the balance is supplied with energy, the indicator [*] is displayed.



To switch on press the **ON/OFF** button.

All symbols of the display light up shortly.

The balance will carry out a self-test

The motor noise of the loading system for the internal adjustment weight can be heard. When „Aut.Cal“ will be displayed the internal adjustment is carried out (see chap. 6.8.1).

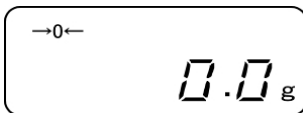
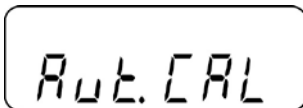

As soon as the weight display appears, the balance is ready for weighing.

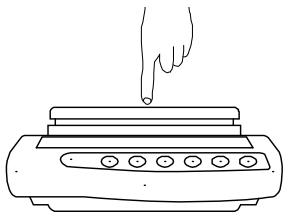

Check the reaction of the weight display via finger pressure.

6.6.2 Models PNS



As soon as the balance is supplied with energy, the indicator [*] is displayed.



To switch on press the **ON/OFF** button.

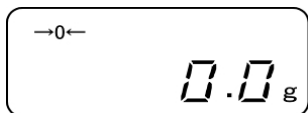

All symbols of the display light up shortly.

The balance is ready for weighing when the weight display appears.

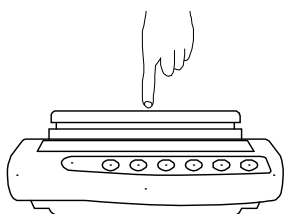

Check the reaction of the weight display via finger pressure.

6.7 Connection of peripheral devices

Before connecting or disconnecting of additional devices (printer, PC) to the data interface, always disconnect the balance from the power supply.

With your balance, only use accessories and peripheral devices by KERN, as they are ideally tuned to your balance.

6.8 Adjustment

As the acceleration value due to gravity is not the same at every location on earth, each display unit with connected weighing pan must be coordinated - in compliance with the underlying physical weighing principle - to the existing acceleration due to gravity at its place of location (only if the weighing system has not already been adjusted to the location in the factory). This adjustment process must be carried out for the first commissioning, after each change of location as well as in case of fluctuating environment temperature. To receive accurate measuring values it is also recommended to adjust the display unit periodically in weighing operation.



- Observe stable environmental conditions. Stabilisation requires a certain warm-up time.
- Ensure that there are no objects on the weighing pan.
- When the **PRINT**-key is pressed during the adjusting procedure, [STOP] will be displayed and adjustment interrupted. The balance returns to weighing mode.
- At the models with internal adjustment weight (KERN PNJ) the adjustment with external weight is not possible.
- The following error messages may be displayed during adjustment.

1-Err Wrong adjustment weight (< 50% max)

2-Err Divergence last external adjustment > 1%

3-Err Weighing pan loaded

4-Err Divergence from last internal adjustment > 1%

A-Err Internal adjustment automatics defective

Err 710 Instable environmental conditions

6.8.1 Adjustment with internal weight (only models PNJ)

The internal adjustment weight is available at all times for starting adjustment via keyboard stroke.

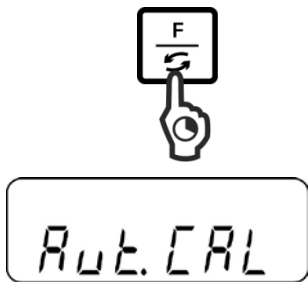

Press the **F**-key and keep pressed until „Aut.CAL“ is displayed.

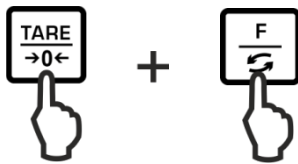

With pressed **TARE** key, press the **F**-key, then release both keys at the same time.

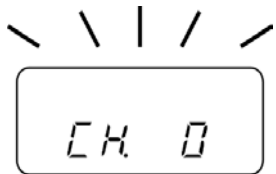

The motor noise of the loading system for the internal adjustment weight can be heard, the internal adjustment is started.

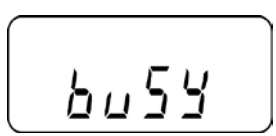
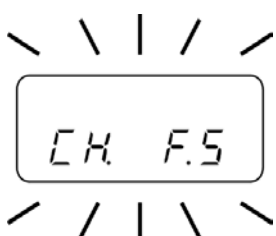
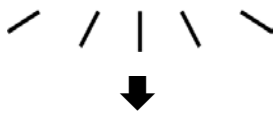

After successful adjustment the balance automatically returns to weighing mode.

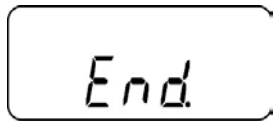

In case of an adjustment error (e.g. objects on the weighing pan) the display will show an error message, repeat adjustment.



The adjustment protocol output is started upon connection to an optional printer and activated GLP function (see chap. 11.2.1).

6.8.2 Adjustment with external weight (only models PNS)

Carry out adjustment as near as possible to the balance's maximum weight (recommended adjustment weight see chap. 1).

Info about adjustment weights can be found on the Internet at:

<http://www.kern-sohn.com>



Press the **F**-key and keep pressed until „CAL“ is displayed.

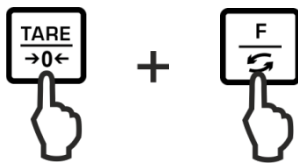

With pressed **TARE key**, press the **F**-key, then release both keys at the same time.



Ensure that there are no objects on the weighing pan.

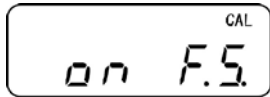

With display „on FS“ place the required adjustment weight carefully in the center of the weighing pan.

The adjustment process is started.

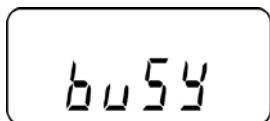
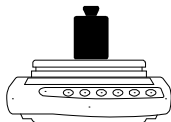

After successful adjustment the balance automatically returns to weighing mode.

In case of an adjustment error (e.g. objects on the weighing pan) the display will show an error message, repeat adjustment.



example

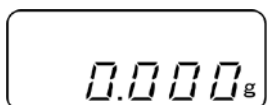

Take away adjustment weight.

6.9 Verification

General hints

According to EU directive 90/384/EEC or 2009/23EG balances must be officially verified if they are used as follows (legally controlled area):

- a) For commercial transactions if the price of goods is determined by weighing.
- b) For the production of medicines in pharmacies as well as for analyses in the medical and pharmaceutical laboratory.
- c) For official purposes
- d) For manufacturing final packages

In cases of doubt, please contact your local trade in standard.

Verification notes:

An EU type approval exists for balances described in their technical data as verifiable. If a balance is used where obligation to verify exists as described above, it must be verified and re-verified at regular intervals.

Re-verification of a balance is carried out according to the respective national regulations. The validity for verification of balances in Germany is e.g. 2 years.

The legal regulation of the country where the balance is used must be observed!

i Verification of the balance is invalid without the seal.

The seal marks attached on balances with type approval point out that the balance may only be opened and serviced by trained and authorised specialist staff. If the seal mark is destroyed, verification loses its validity. Please observe all national laws and legal regulations. In Germany a re-verification will be necessary.

Position seals and verification switch

Prior to verification, the verification switch must be moved into the verification position. In this position the display shows a bracket around the last display point. After verification the balance is sealed at the indicated positions.

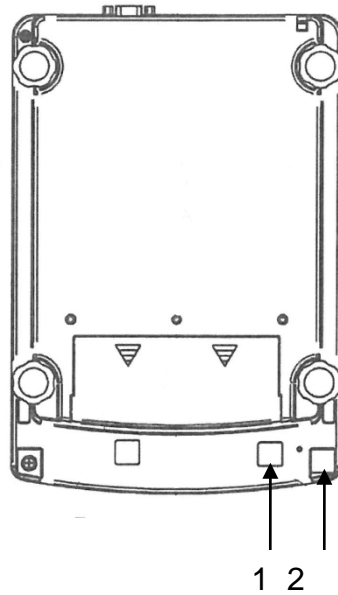

Models d = 0.001g

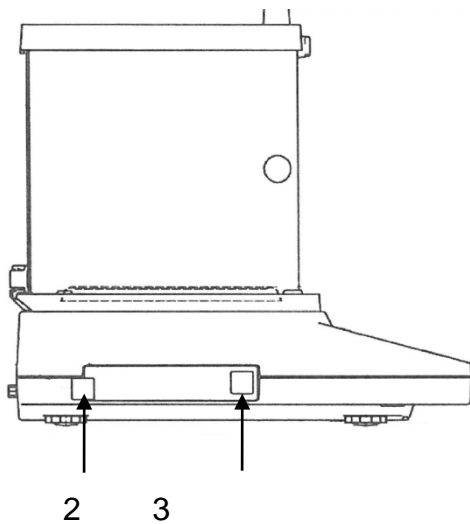

Models d = 0.01g / 0.1 g

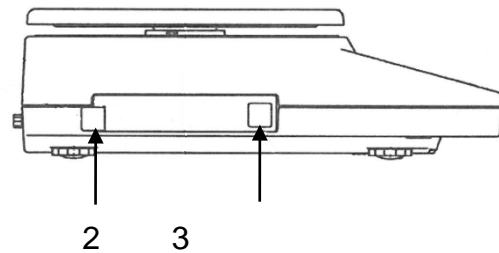

- 1 Switch cover / Position verification switch
- 2 Self-destroying seal mark
- 3 Metrology mark [M]

7 Basic Operation

7.1 Start-up



As soon as the balance is supplied with energy, the indicator [*****] is displayed.



To switch on press the **ON/OFF** button.

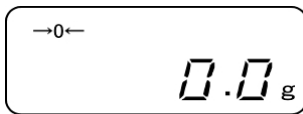

All symbols of the display light up shortly.

The balance is ready for weighing when the weight display appears.

7.2 Switch into stand-by mode

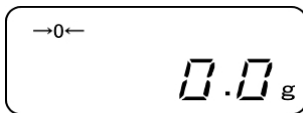

Press **ON/OFF** button, the display disappears

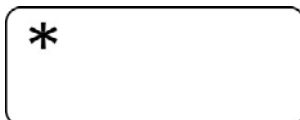

The indicator [*****] will be shown.



- In stand-by mode the balance is ready for operation immediately after switching-on without warm-up time.
- To switch off the balance completely, separate it from the mains.
- The balance starts in the mode, in which it has been switched off.

7.3 Zeroing

In order to obtain optimal weighing results, reset to zero the balance before weighing.



Unload the balance.
Press the **TARE** key.

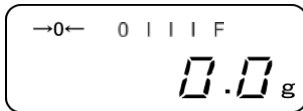

Wait until the zero display and the indicator a will appear.



During the zeroing procedure a flashing „M“ will be displayed.

7.4 Simple weighing

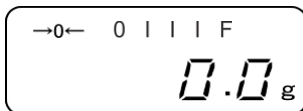

Place goods to be weighed on balance.



Wait for stability display ○ .
Read weighing result.



➤ **Capacity display** [0||||||| F]

At active capacity display (see chap. 8.1.2 „1.b.G.1“) the bar graph moves from the left to the right and proceeds equally to the weight loaded onto the weighing balance. Its full width is reached at maximum load. This is an analogue display of the current allocation of the weighing area.

➤ **Overload warning**

Overloading exceeding the stated maximum load (max) of the device, minus a possibly existing tare load, must be strictly avoided. This could damage the instrument.

Exceeding maximum loads is indicated by the display of “o-Err“, and an audio sound. Unload weighing system or reduce preload.

7.5 Unity change

By repeated pressing of the F-key the weight value can be switched over by factory into the following units.

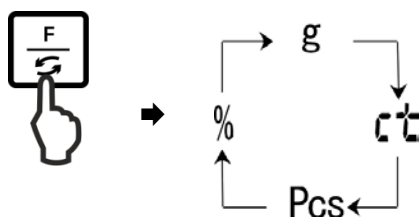

Changes can be set in the menu (function 81.s.u – 85.s.u).

Function	Description
81.s.u	Adjustment of the first weighing unit where the balance has to display the weighing result.
82.s.u	Adjustment of the second weighing unit where the balance has to display the weighing result.
83.s.u	Adjustment of the third weighing unit where the balance has to display the weighing result.
84.s.u	Adjustment of the fourth weighing unit where the balance has to display the weighing result.
85.s.u	Adjustment of the fifth weighing unit where the balance has to display the weighing result.



Func



1.b.G. 1

Call up menu:

Press the **F**-key and keep pressed until „Func“ is displayed.

When releasing the button, the first function „1.b.G.“ is displayed with the current setting.

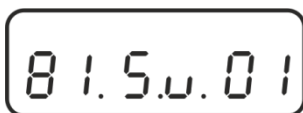
**Call function:**

Press repeatedly the **F**-button until „81.Su.“ with the current setting is displayed.

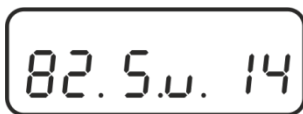

Use the **F**-key to select the weighing unit to be changed e.g. „82.s.u“.

**Change settings:**

e.g. function „82.s.u“ [ct] in [lb]:

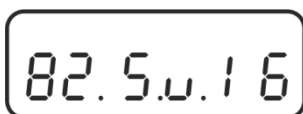

In order to change the current setting of [Karat] „82.Su.14“ e.g. in [Pound] press the **TARE**-key repeatedly until „82.Su.16“ will be displayed.

For available settings see chap. 8.1.2

To change other units, select the next function („83.s.u“ – „85.s.u „) using the **F**-key and change as described above.

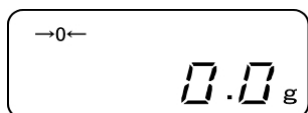
**Save / back to weighing mode:**

Confirm settings with **SET**-key. The balance returns to weighing mode.

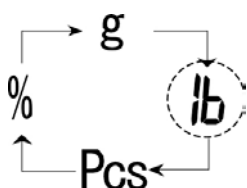
**Unit change:**

By repeated pressing of the **F**-key the weight value can be switched over now into the following units.



- Navigation in menu, see chap.
- After that no more switch-over in another unit will be possible with setting „00“.
- Setting „00“ is not available with function „81.s.u“.
- For balances with type approval not all weighing units are available.

7.6 Weighing with tare

7.6.1 Taring

The dead weight of any weighing container may be tared away by pressing a button, so that the following weighing procedures show the net weight of the goods to be weighed.

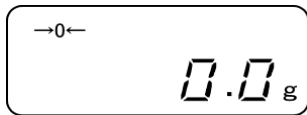

Set balance to zero

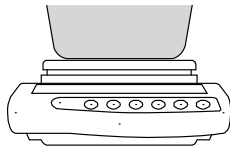

Deposit empty weighing container. The result is displayed.



Wait for stability display, then press the **TARE** button. The weight of the container is now internally saved. The zero display and „Net“ will appear. „Net“ signals that all shown weight values are net values.

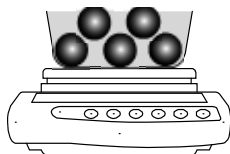
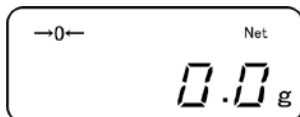

Weigh the material, the net weight will be indicated.

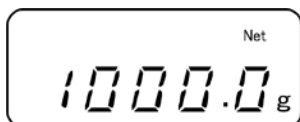

- When the balance is unloaded the saved taring value is displayed with negative sign.
- To delete the stored tare value, remove load from weighing pan and press the **TARE** button.

7.6.2 Multiple tare

The taring process can be repeated any number of times, e.g. when adding several components for a mixture (adding). The limit is reached when the taring range capacity is full.

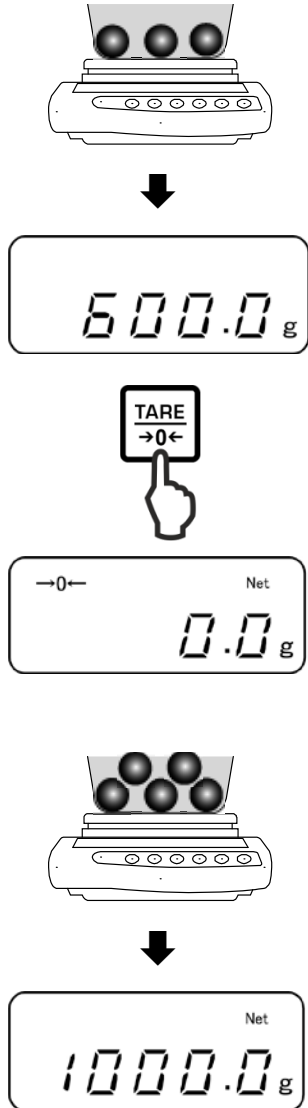

Place first good to be weighed on balance. The result is displayed.

Wait for stability display, then press the **TARE** button
The zero display and „**Net**“ will appear.

Weigh-in the second weighing material. The weight of the second weighing good is displayed.

For more weighing material repeat the two last steps.

8 Menu

8.1 Menu [function]

8.1.1 Navigation in the menu

1. Access to menu

⇒ In weighing mode keep the **F**-key pressed down until **[FWnm]** appears on the display. Release button. The first menu item showing the current setting will be displayed.

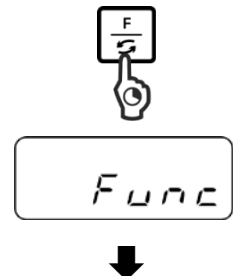

2. Select menu items

⇒ Press the **F**-key to select the individual menu items showing the current settings one by one.

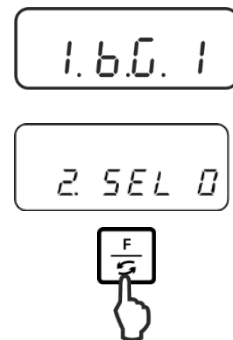

3. Change settings

⇒ Press the **TARE**-key to change the setting of a selected menu item. Each time the **TARE**-key is pressed the next setting will be displayed. As soon as the desired setting appears on the display you can select the next menu item with the **F**-key (see step 3) or exit the menu (see step 4 / 5)

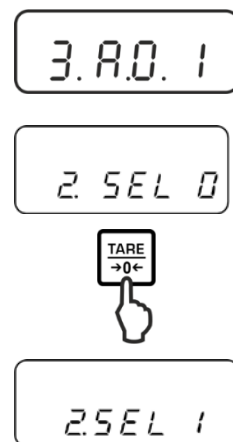

4. How to save settings and to exit the menu

⇒ Press the **S**-key; balance will return to weighing mode.

or

⇒ Press the **F**-key repeatedly until the weighing balance returns to weighing mode.

All changes will be saved.





5. Cancel

⇒ Press the **PRINT**-key briefly; balance will return to weighing mode. Changes will not be saved.



8.1.2 Menu overview

Factory settings are marked by *.

Menu item			Description
Capacity display	1. <i>bc.</i>	1	Hide capacity display
		* 2	Display capacity display
Tolerance weighing see chap. 9.3	2. <i>SEL</i>	* 0	Disable tolerance weighing
		1	Enable tolerance weighing Settings see chap. 9.3.1
Automatic zero point correction see chap. 10.1	3. <i>AO</i>	0	Automatic zero tracking off
		* 1	Automatic zero tracking on
Automatic shutdown for battery operation	4. <i>AP.</i>	0	Not documented (function is only available in rechargeable battery operation)
		* 1	

Display speed see chap. 10.2	5 rE.	0	Setting for dosage	
		1	Very quiet and stable environment. The balance works very fast but is sensitive to outside influences.	
		2	↕	
		* 3	Normal conditions. Weighing balance working at medium speed.	
		4	↕	
		5	Busy environment. The balance works slower, but is insensitive to outside influences	
Adapt standstill control see chap. 10.2	6 S. d.	1	The balance works very fast	
		* 2	The balance works at medium speed	
		3	↕	
		4	The balance works with the utmost precision	
RS232C-interface	7. 1 F.	0	Deactivated	
		* 1	6-digit data format	Settings see chap. 11
		2	7-digit data format	
Change weighing unit see chap. 7.5 Not all units are available in verified weighing balances	81 Su.	*1 01	[g]	
		*2 14	[ct]	
		15	[oz]	
		16	[lb]	
		17	[ozt]	
		18	[dwt]	
		19	[gn]	
		1A	[tl_HK]	
		1b	[tl_Singap. Malays]	
		1C	[tl_Tw]	
		1d	[mom]	
		1E	[tol]	
		*3 20	[Pcs]	
		*4 1F	[%]	
00	After that no more switch-over in another unit will be possible.			

Only models PNJ	Edit adjustment log see chap. 11.2.1	0. CLP	0	No	
			* 1	Yes	
	Data output of verified models (settings only available in a non verified status)	A. PrF	1	Data output disabled	
			2	Data output enabled	Sample protocol: <div style="border: 1px solid black; padding: 2px; display: inline-block;">+0075.55 G S</div>
			* 3	Data output enabled. Non verified value separated by „/“	Sample protocol: <div style="border: 1px solid black; padding: 2px; display: inline-block;">+0075.5/5 G S</div>
	Set the date format see chap. 10.6	b. dAt.	1	Display in year-month-day	
			2	Display in month-day-year	
			* 3	Display in day-month-year	
	Edit date / time on protocol see chap. 11.2.2	C. tO.	0	Edit weighing value without date / time	
			* 1	Edit weighing value with time	
			2	Edit weighing value without date + time	
	Adjust back lighting of the display	d. bL	0	No	
* 1			Yes		
Switch-off the back lighting of the display automatically, see chap. 10.4	E. Ab	0	No		
		* 1	Yes		

8.2 Menu [Function2]

8.2.1 Navigation in the menu

Access to menu

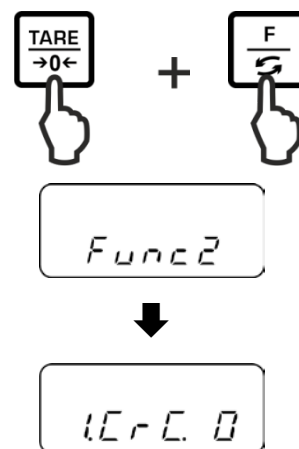

- ⇒ In weighing mode press the **F**-key and the **TARE**-key at the same time and keep it pressed until „Func2“ will be displayed.
- ⇒ When released, the first menu item „1.CrC. 0.“ is displayed.



Select the menu items, change and take over settings see chap. 8.1.1

8.2.2 Menu overview

Default setting is marked by *.

Menu item			Description
Display software status see chap. 10.3	1. CrC.	* 0	no
		1	yes
	2. S.C.t.	* 0	Not documented
		1	
Setting date / time, see chap. 10.5	3. d. SEt	* 0	no
		1	yes

9 Applications

9.1 Parts counting

Before the balance can count parts, it must know the average part weight (i.e. reference). Proceed by putting on a certain number of the parts to be counted. The balance determines the total weight and divides it by the number of parts, the so-called reference quantity. Counting is then carried out on the basis of the calculated average piece weight.

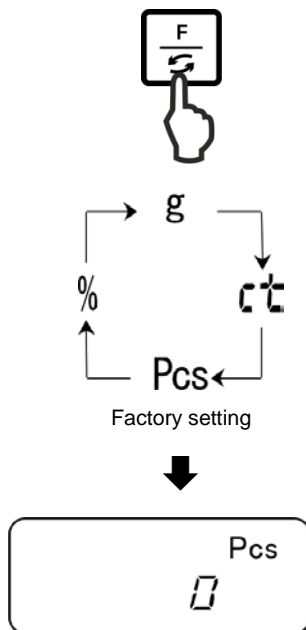

1. Call application

Press the **F**-button repeatedly until „Pcs“ is displayed.

2. Set to zero/taring

Press the **TARE**-button to set the balance to zero or to tare when using a weighing container.

3. Reference setting

Press **SET**-key.

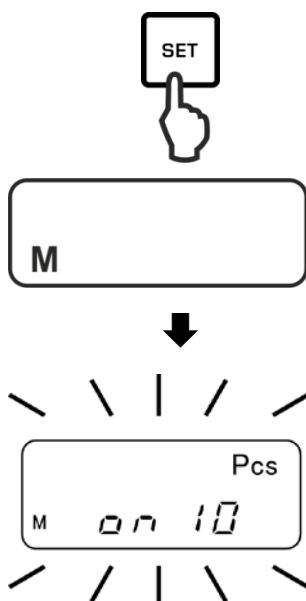

Wait until the currently set reference quantity will flash in the display.

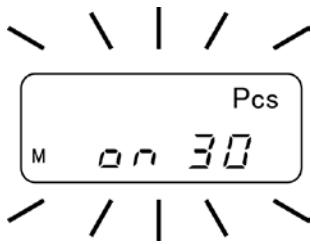

4. Change reference quantity

Select the desired reference quantity using the **TARE**-key, e.g. 30 items. You can choose

10 → 30 → 50 → 100

Important:

The higher the reference quantity the higher the counting exactness.

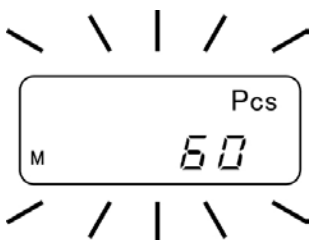
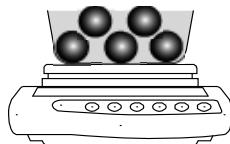
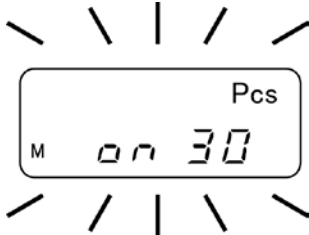
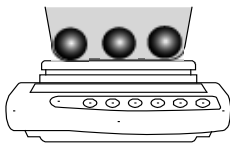

5. Weigh-in reference parts

Place as many pieces to add-up as required by the set reference piece number.

Use the **SET** key to confirm.

6. Reference optimisation

For reference optimisation place again the same quantity of counted pieces.

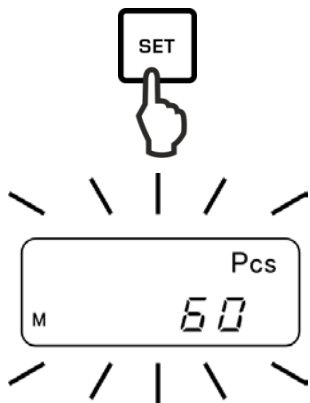

Use the **SET** key to confirm.

At every reference optimisation, the reference weight is calculated anew. As the additional pieces increase the base for the calculation, the reference also becomes more exact.

For further reference optimisation place more counted pieces (approx. 1/2 to 1/5 of the counted material). Execution see step 5.

7. How to save the reference



Press the **PRINT**-key to save the reference whereupon the weighing scale automatically calculates an average weight per part.

Remove reference weight. The balance is now in parts counting mode and counts all units on the weighing pan.

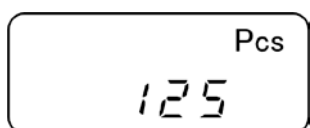

8. Count the items

Place load on pan and read the number of pieces.

Sample protocol (KERN YKB-01N)

+0000125 PC S

9. Printing

The display value will be printed out by connecting an optional printer and pressing the **PRINT**-key (factory setting).



Display Description

- ADD** The number of pieces placed is too small for a correct reference calculation.
Either you accept the error and confirm by pressing the **PRINT**-key or you add additional items.
- L-ERR** Piece below minimum weight of piece (see **chap. 1** "Technical specifications"):

To interrupt a reference calculation, press the **PRINT**-key.

The reference weight will remain stored even after the weighing balance was turned off until the reference is reset.

9.2 Percent determination

Percentage calculation facilitates weight display in percent related to a reference weight equivalent to 100 %.

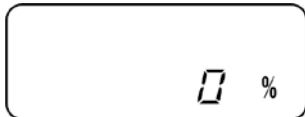
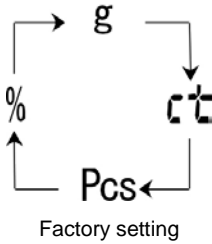

1. Call application

Press the **F**-button repeatedly until „%“ is displayed.

2. Zeroing/taring

Press the **TARE**-button to set the balance to zero or to tare when using a weighing container.

3. Reference setting (100 % value)

Press **SET**-key.

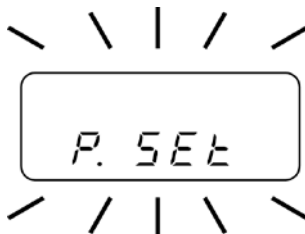

Wait until „**P. SET**“ will be displayed.

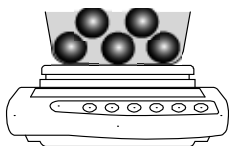

Place the reference weight (= 100 %) and confirm by pressing the **PRINT**-key.

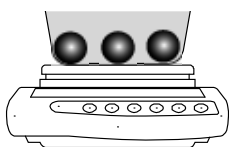
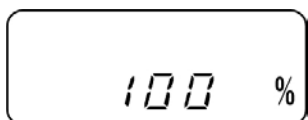

4. Percent determination

Place goods to be weighed on balance. The weight of the sample is displayed in percentage in terms of the reference weight.

Sample protocol (KERN YKB-01N)

+00033.33 % S

5. Printing

The display value will be printed out by connecting an optional printer and pressing the **PRINT**-key (factory setting).

i	Display	Description
	1 %	Minimum load \leq reference weight < minimum load x 10
	0.1 %	Minimum load x 10 \leq reference weight < minimum load x 100
	0.01 %	Minimum load x 100 \leq reference weight
	L-ERR	Reference weight < Minimum weight = underload (minimum load depending on model, see chap. 1 „Technical data“)

The reference weight (100 %) will remain stored even after the weighing balance was turned off until the reference is reset.

9.3 Weighing with tolerance range

Using the application „Weighing with tolerance range“ you can set an upper or lower limit value and thus ensure that the weighed load remains exactly within the set tolerance limits.

Limit value inputs are possible at the functions weighing, parts counting and percentage determination.

There are two different ways to set the tolerance limits:

1. By weighing, that is by placing item on weighing balance and saving this value as nominal weight, see chap. 9.3.2
2. Numeric input of nominal values via keyboard, see chap. 9.3.3

Display of the results:

The triangular tolerance marker [◀] in the display of the display shows whether the goods to be weighed are within the two tolerance limits. The tolerance mark is only visible when function „2.SEL 1“ is enabled (see chap. 9.3.1).



The tolerance mark provides the following information:

1. Menu setting „23.Pi. 2“ / two limit values

Load below specified tolerance

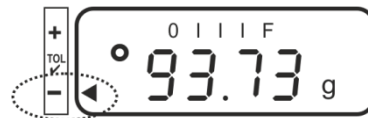

Load within specified tolerance



Load exceeds specified tolerance



2. Menu setting „23.Pi. 1“ / one limit value

Weighing good < Target weight

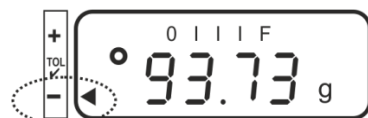

Target weight reached



Weighing good > Target weight

No information

9.3.1 Enable function / settings in menu

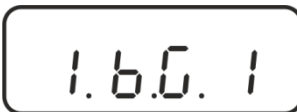
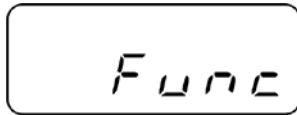

Call up menu:

Press the **F**-key and keep pressed until „Func“ is displayed.

When releasing the button, the first function „1.b.G.“ is displayed with the current setting.

Enable function for tolerance weighing „2.SEL. 1“:

Press the **F**-key until „2.SEL.“ with the current setting is displayed.

Enable the function using the **TARE**-key.

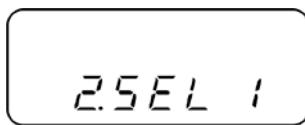

„2.SEL. 0“ Function deactivated

„2.SEL. 1“ Function activated

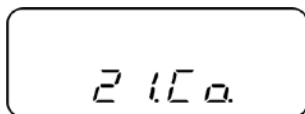

Use the **F**-key to select the next menu item „21.Co.“ for setting the display conditions for the tolerance mark.

Use the **TARE**-key to select the desired setting

„21.Co. 1“ The tolerance mark is displayed with stable and instable weighing values

„21.Co. 2“ The tolerance mark is only displayed with stable weighing values.



Use the **F**-key to select the next menu item „22.Li.“ for setting the tolerance range.

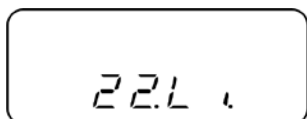

Use the **TARE**-key to select the desired setting

„**22.Li. 0**“ The tolerance mark is only displayed above zero range (> 5 d).

„**22.Li. 1**“ Tolerance marker is displayed for the whole range.



Use the **F**-key to select the next menu item “23.Pi. for setting the number of limit points.

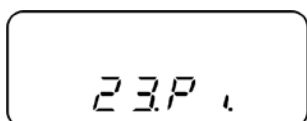

Use the **TARE**-key to select the desired setting

„**23.Pi. 1**“ 1- Limiting point (OK/ -)

„**23.Pi. 2**“ 2- Set the limit point as lower and upper limit (+ / OK / -)



Save / back to weighing mode:

Confirm settings with **SET**-key. The balance returns into the tolerance weighing mode



9.3.2 Tolerance check after setting the limit values by weighing

1.

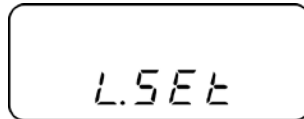

Press the **SET**-key and keep it pressed until the display for setting the lower limit value „L.SET“ appears. The current setting flashes.

2.

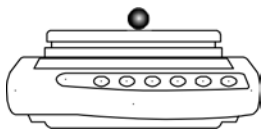

Place the nominal weight (e.g. 95 g) for the lower limit value and confirm with **PRINT**-key.

For menu setting „23.Pi. 1“ the input finishes here. Start tolerance check, see step 4.

For menu setting „23.Pi. 2“ wait until the display „H.SET“ for setting the upper limit value appears. The current setting flashes.



3.

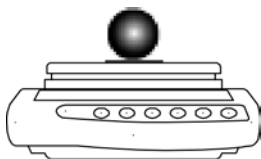
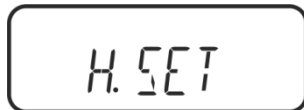

Place the nominal weight (e.g. 105 g) for the upper limit value and confirm with **PRINT**-key.



Remove the nominal weight. From here evaluation takes place whether the goods to be weighed are within the two tolerance limits.

4.

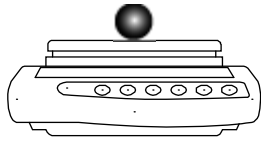

Start tolerance check

If necessary, place an empty container on the balance and tare it.

Place goods to be weighed on balance. With the help of the tolerance mark [◀] check if the weighed goods are under, inside or over the default tolerance.

Sample displays:



Load below specified tolerance



Load within specified tolerance



Load exceeds specified tolerance

5.

**Sample protocols
(KERN YKB-01N)**

+100.73 GGS

Load within specified tolerance

+093.73 GLS

Load below specified tolerance

+107.03 GHS

Load exceeds specified tolerance

Printing

The display value will be printed out by connecting an optional printer and pressing the **PRINT**-key (factory setting).

G	Weighing unit "gram"
G	Load within specified tolerance
S	Stable value
L	Load below specified tolerance
H	Load exceeds specified tolerance

9.3.3 Tolerance check after numeric input of the limit values

1.

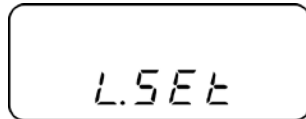

Press the **SET**-key and keep it pressed until the display for setting the lower limit value „L.SET“ appears. The current setting e.g. „70.00 g“ flashes.

2.



For numeric input of the nominal weight (e.g. 95 g) press the **TARE**-key for the lower limit value. The last digit flashes.

Numeric input:



To change a digit press the **TARE**-key.



Select digit using the **F**-key (from the right to the left). The selected digit is flashing.



Store entry



For menu setting „**23.Pi. 1**“ the input finishes here. Start tolerance check, see step 4.

3.



For menu setting „23.Pi. 2“ wait until the display „H.SET“ for setting the upper limit value appears. The current setting flashes.



For numeric input of the nominal weight (e.g. 105 g) press the **TARE**-key for the upper limit value. The last digit flashes.

Numeric input see step 2.



Save input with XX. The balance returns into the tolerance weighing mode



From here evaluation takes place whether the goods to be weighed are within the two tolerance limits.

4.

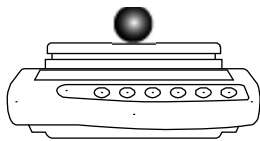

Start tolerance check

If necessary, place an empty container on the balance and tare it.

Place goods to be weighed on balance. With the help of the tolerance mark [◀] check if the weighed goods are under, inside or over the default tolerance.

Display example see chap. 9.3.2

5.

Printing

The display value can be printed out by connecting an optional printer and pressing the **PRINT**-key (factory setting), sample protocols, see chap. 9.3.2

10 General functions

10.1 Zero-tracking

This function is used to tare small variations in weight automatically.

In the event that small quantities are removed or added to the material to be weighed, incorrect weighing results can be displayed due to the “stability compensation”. (e.g. slow flow of liquids from a container placed on the balance, evaporating processes).

When apportioning involves small variations of weight, it is advisable to switch off this function.

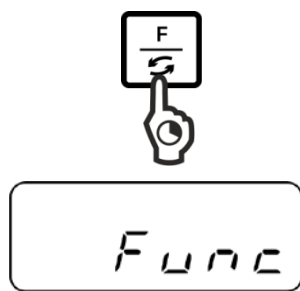

Call up menu:

Press the **F**-key and keep pressed until „Func“ is displayed.

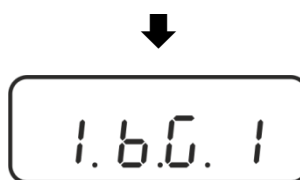

When releasing the button, the first function „1.b.G.“ is displayed with the current setting

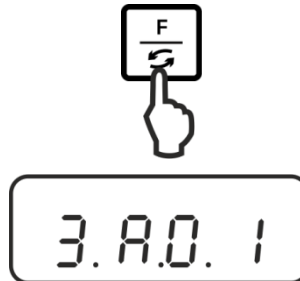

Enable/disable zero-tracking function:

Press **F**-key repeatedly until „3.A0.“ with the current setting is displayed.

Use the **TARE**-key to select the desired setting.

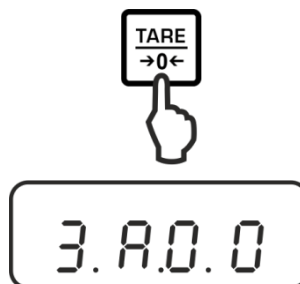

„3.A0 1“ Function activated

„3.A0 0“ Function deactivated

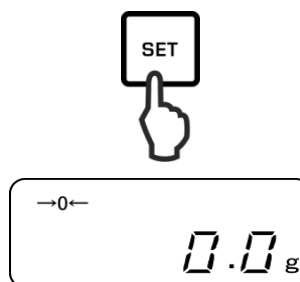

Save / back to weighing mode:

Confirm setting with **SET**-key. The balance returns to weighing mode.

10.2 Settings for Stability and Response

Exists the possibility to tune the stability of the display and the degree of reaction of the balance to the requirements of certain applications or the environmental conditions.

Please note that in general slowing down reaction times result in higher stability of the set data handling, while speeding up reaction times have an influence on the stability deterioration.

Installation site	Menu setting „5.rE.“	Menu setting „6.S.d“
Quiet ↑↓ Busy	1	1
	2	2
	3	3
	4	4
	5	

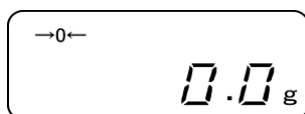
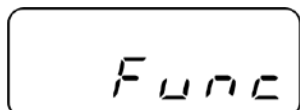

Press the **F**-key and keep pressed until „Func“ is displayed.

When releasing the button, the first function „1.b.G.“ is displayed with the current setting.

Press **F**-key repeatedly until „5.rE.“ or „6S.d“ with the current setting is displayed.

Use the **TARE**-key to select the desired setting.

Save / back to weighing mode:

Confirm setting with **SET**-key. The balance returns to weighing mode.

10.3 Show software status (only models PNJ)

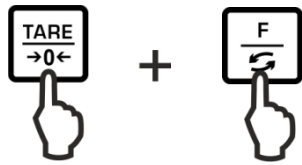

Press the **F**-key and the **TARE**-key at the same time and keep them pressed until „Func2“ will be displayed.

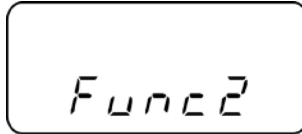

When released, „1.CrC. 0.“ is displayed.

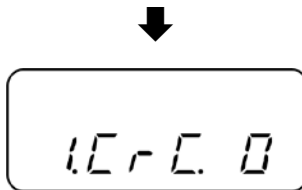

Use the **TARE**-key to select the setting „1.CrC. 1.“

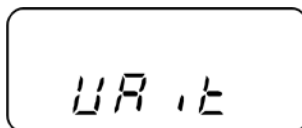
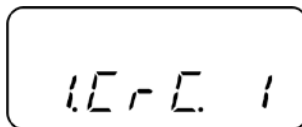

Press **F**-key. Wait until the software status of the balance is displayed.

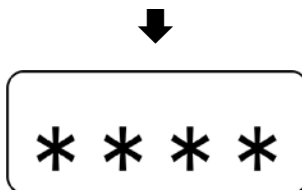

Return to weighing mode:

Press the **F**-key repeatedly.

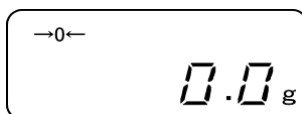

10.4 Switch-off background illumination of the display automatically (only models PNJ)

When function is enabled background illumination of display will automatically switch off after 1 minute during which there was no change of load or activity.

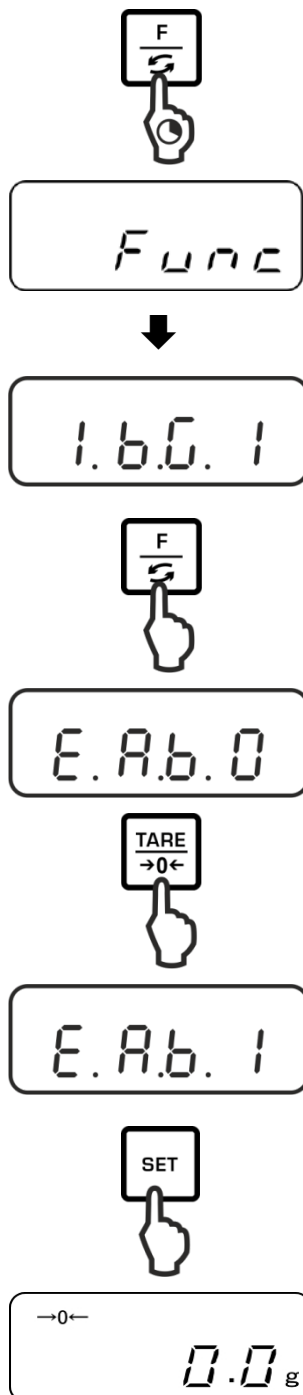

Call up menu:

Press the **F**-key and keep pressed until „Func“ is displayed.

When releasing the button, the first function „1.b.G.“ is displayed with the current setting.

Enable/disable auto-backlight function:

Press repeatedly the **F**-button until „E.A.b.“ appears with the current setting.

Use the **TARE**-key to select the desired setting.

„E.A.b. 0“ Function deactivated

„E.A.b. 1“ Function activated

Save / back to weighing mode:

Confirm setting with **SET**-key.
The balance returns to weighing mode.

10.5 Setting date / time (only models PNJ)

10.5.1 Setting time

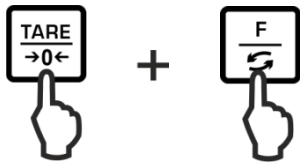

Press the **F**-key and the **TARE**-key at the same time and keep them pressed until „Func2“ will be displayed.

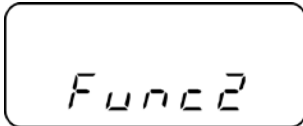

When released, „1.CrC. 0.“ is displayed.

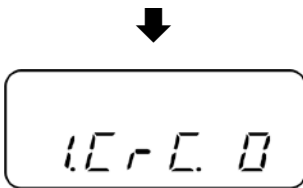

Press **F**-key repeatedly until „3.d.St.0“ is displayed.

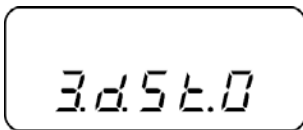

Use the **TARE**-key to select „3.d.St.1“.

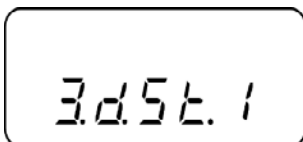

Press **F**-key. „tiME“ is displayed, followed by the current set time.

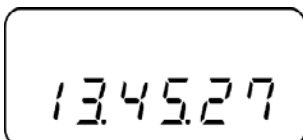
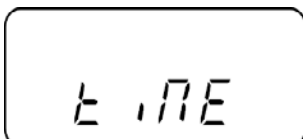

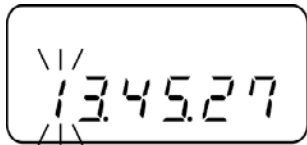

To change the time press the **SET**-key, the first digit flashes.

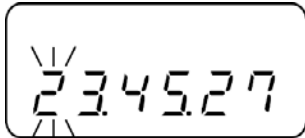

To change a digit press the **TARE**-key.

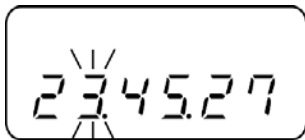

Press the **F**-key to select a digit. The selected digit is flashing.

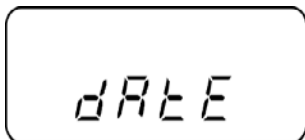

Store entry. The display changes to the currently set date.

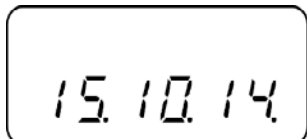

Either change the date as described above or back to weighing mode with **F**-key.

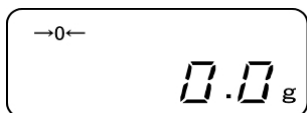

10.5.2 Setting date

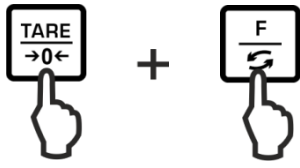

Press the **F**-key and the **TARE**-key at the same time and keep them pressed until „Func2“ will be displayed.



When released, „1.CrC. 0.“ is displayed.

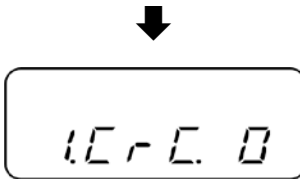

Press **F**-key repeatedly until „3.d.St.0“ is displayed.

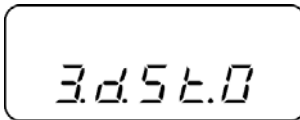

Use the **TARE**-key to select „3.d.St.1“.

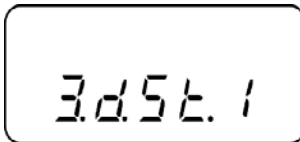

Press **F**-key. „tiME“ is displayed, followed by the current set time.

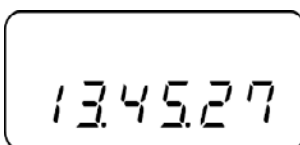
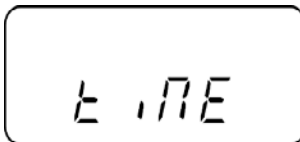



Press **F**-key. „**dAtE**“ is displayed, followed by the currently set date.

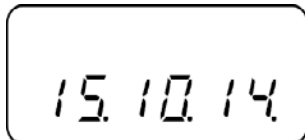
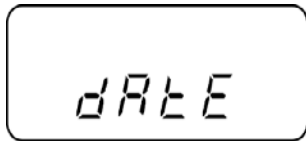

To change the date press the **SET**-key, the first digit flashes.

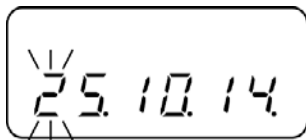
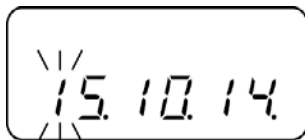

To change a digit press the **TARE**-key.

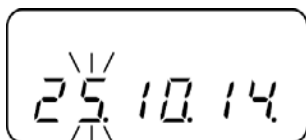

Press the **F**-key to select a digit. The selected digit is flashing.

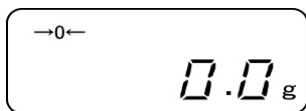

Store entry The balance returns to weighing mode

10.6 Set date format (only models PNJ)

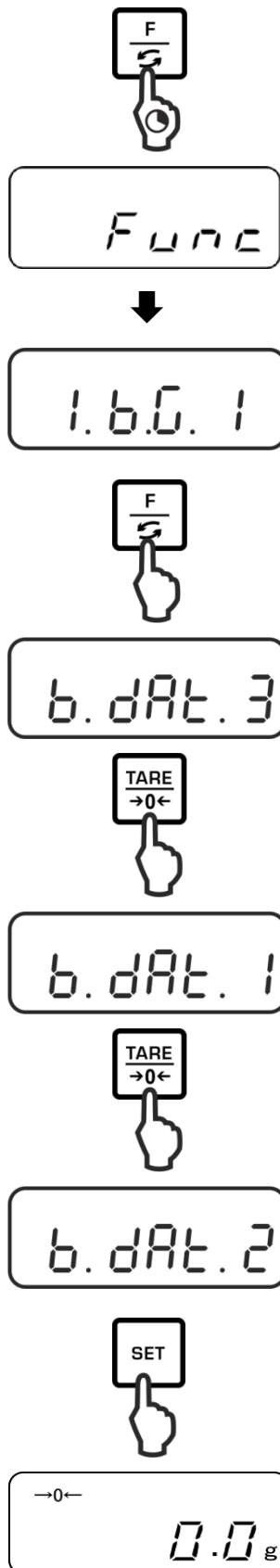

Press the **F**-key and keep pressed until „Func“ is displayed.

When releasing the button, the first function „1.b.G.“ is displayed with the current setting.

Press repeatedly the **F**-button until „b.dAt“ appears with the current setting.

Use the **TARE**-key to select the desired setting.

„b.dAt.3“ „DD.MM.Y“

„b.dAt.1“ „Y.MM.DD“

„b.dAt.2“ „MM.DD.Y“

Save / back to weighing mode

Confirm setting with **SET**-key.
The balance returns to weighing mode.

11 RS232C-interface

11.1 General hints

For the connection of a peripheral device (printer, computer) the balance is as per series equipped with a RS232C-interface.

The following conditions must be met to provide successful communication between the weighing balance and the peripheral devices.

- Connect balance using a suitable cable with the interface of the peripheral device. Faultless operation requires an adequate KERN interface cable.
- Communication parameters (baud rate, bits and parity) of balance and peripheral device must match.

Pin allocation of the balance output plug (Sub-D, 9 poles):

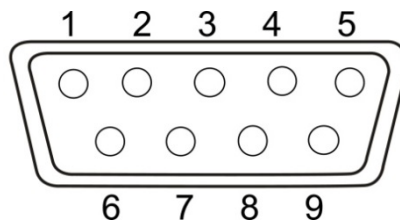

Pin nr.	Signal	Input/Output	Function
1	-		
2	RXD	Input	Receive data
3	TXD	Output	Transmit data
4	DTR	Output	HIGH
5	GND	-	Signal ground
6	-	-	
7	-	-	
8	-	-	
9	-	-	

Interface cable:

- Balance – PC 9-pole

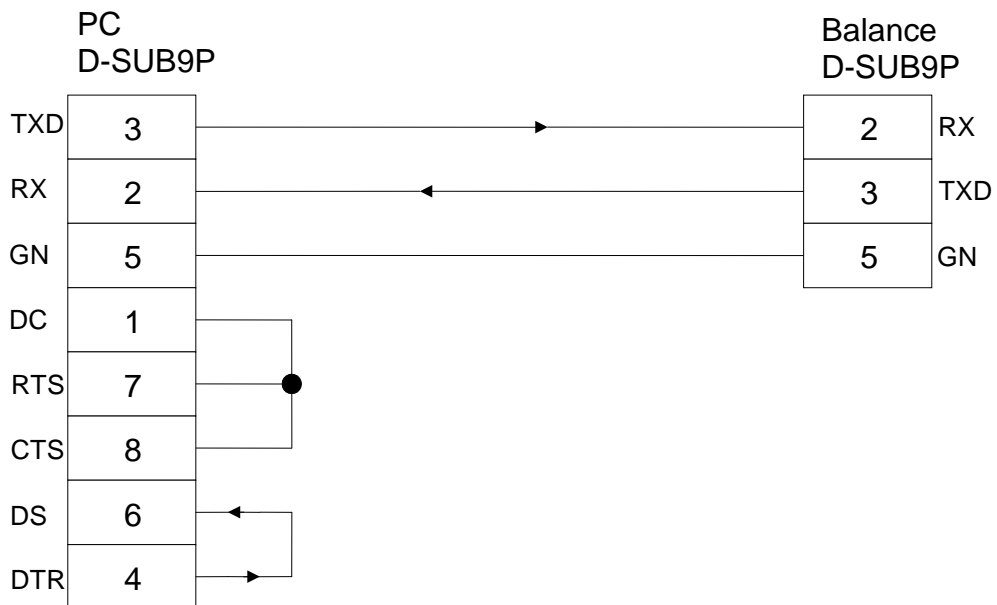

Technical data



1. Baud rate 1200*/2400/4800/9600/19200 bps
2. Transmission code ASCII codes (8/7 bits)
3. Bit setting

Start bit	1 bit
Data bits	8 bits
Parity bit	0* / 1 bit
Stop bits	1 bit
4. Parity None*/Odd/Even

Factory settings are marked by *.

Interface parameters

- i** ➤ The available interface parameters are only shown when function [7 1.F 1] or [7 1.F 2] is enabled.
- Factory settings are marked by *.

Menu item			Description
Output condition	71. O.C.	0	No data output
		1	Continuous data output
		2	Continuous data output stable weighing values
		* 3	Output of stable and instable weighing values after pressing PRINT key
		4	Output with stable weighing value after previous relief of balance
		5	One output with stable weighing value. No output with stable weighing values. Renewed output after stabilization
		6	One output with stable weighing value. Continuous output with instable weighing values.
		* 7	Output of stable weighing values after pressing PRINT key
Baud rate	72. b.L.	* 1	1200 bps
		2	2400 bps
		3	4800 bps
		4	9600 bps
		5	19200 bps
Parity	73. PA.	* 0	No parity bit
		1	Odd parity
		2	Even parity
			During setting only [7 1.F 2]

11.2 Printer operation

Make sure that the balance is connected to the printer interface by a suitable cable and the communication parameters (baud rate, bits and parity) of balance and printer are matching.

11.2.1 Edit an ISO/GLP/GMP-conform adjustment log (only models PNJ)

Quality assurance systems require printouts of weighing results as well as of correct adjustment of the balance stating date and time and balance identification. The easiest way is to have a printer connected.

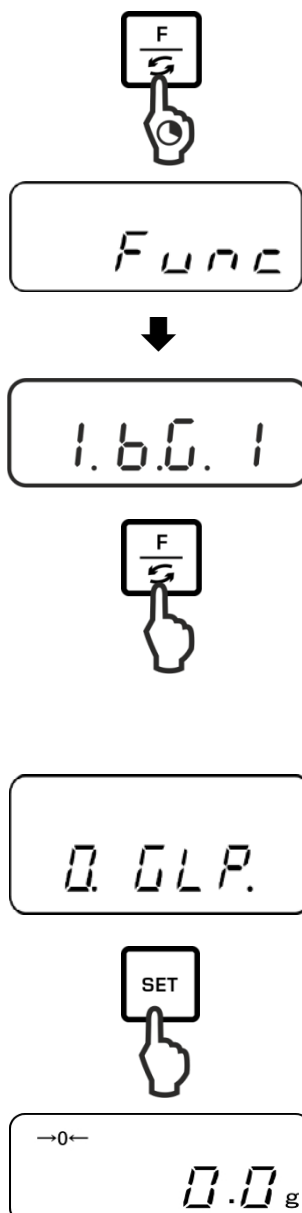

Press the **F**-key and keep pressed until „Func“ is displayed.

When releasing the button, the first function „1.b.G.“ is displayed with the current setting.

Press repeatedly the **F**-button until „**0.GLP.**“ with the current setting is displayed.

Use the **TARE**-key to select the desired setting.

„**0.GLP.0**“ Adjustment protocol output de-activated

„**0.GLP.1**“ Adjustment protocol output activated

Save / back to weighing mode:

Confirm setting with **SET**-key.

The balance returns to weighing mode.

Sample protocol (KERN YKB-01N):

```
CALIBRATION
KERN & SOHN
MODEL:
      PNJ 3000-2M
S/N      190001833
ID:
DATE:    15.09.2015
TIME:    10:27
*CAL.END
NAME:

*****
```

11.2.2 Protocol output with current date / time (only models PNJ)

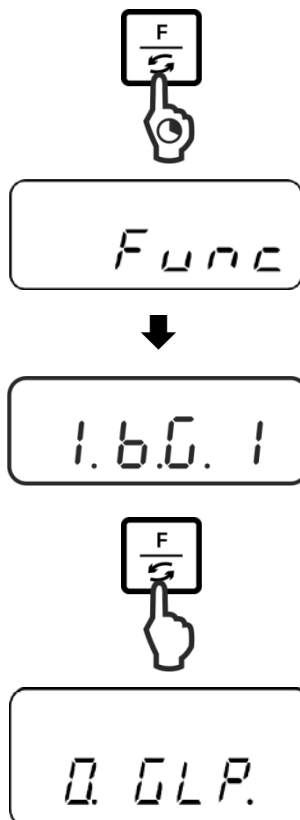

Press the **F**-key and keep pressed until „Func“ is displayed.

When releasing the button, the first function „1.b.G.“ is displayed with the current setting.

Press repeatedly the **F**-button until „**C.t.o.**“ appears with the current setting.

Use the **TARE**-key to select the desired setting.

„**C.t.o.0**“ Edit weighing value without date / time

„**C.t.o.1**“ Edit weighing value with time

„**C.t.o.2**“ Edit weighing value with date + time

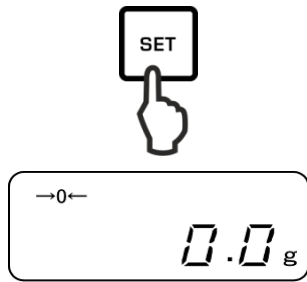

Save / back to weighing mode

Confirm setting with **SET**-key.
The balance returns to weighing mode.

Sample protocols (KERN YKB-01N)

„C.t.o. 0“

+0075.55 G S

„C.t.o. 1“

09:48:39
+0075.55 G S

„C.t.o. 2“

17.09.2015
09:48:39
+0075.55 G S

11.3 Data output

11.3.1 Data transmission format

You can adapt the format of data transfer (6 or 7 digits) to your requirements in the menu.

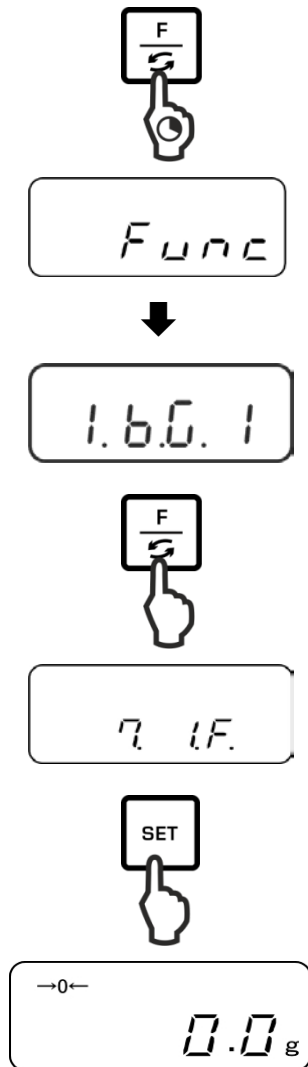

Press the **F**-key and keep pressed until „Func“ is displayed.

When releasing the button, the first function „1.b.G.“ is displayed with the current setting..

Press **F**-key repeatedly until „7.I.F.“ with the current setting is displayed.

Use the **TARE**-key to select the desired setting.

„7.I.F.1“ 6-digit data format

„7.I.F.2“ 7-digit data format

Save / back to weighing mode:

Confirm setting with **SET**-key.
The balance returns to weighing mode.

6-digit data format, consisting of 14 characters, including terminator; CR=0DH, LF=0AH (CR=weighing balance reverse / LF=line indent).

1	2	3	4	5	6	7	8	9	10	11	12	13	14
P1	D1	D2	D3	D4	D5	D6	D7	U1	U2	S1	S2	CR	LF

7-digit data format, consisting of 15 characters, including terminator; CR=0DH, LF=0AH (CR=weighing balance reverse / LF=line indent). A parity bit can be appended.

1	2	3	4	5	6	7	8	9	10	11	12	13	14	15
P1	D1	D2	D3	D4	D5	D6	D7	D8	U1	U2	S1	S2	CR	LF

6-digit data format of verified models, consisting of 15 characters, including terminator; CR=0DH, LF=0AH (CR=weighing balance reverse / LF=line indent). The oblique “/” is printed just before the last digit.

1	2	3	4	5	6	7	8	9	10	11	12	13	14	15
P1	D1	D2	D3	D4	D5	D6	D7	D8	U1	U2	S1	S2	CR	LF

7-digit data format of verified models, consisting of 15 characters, including terminator; CR=0DH, LF=0AH (CR=weighing balance reverse / LF=line indent). A parity bit can be appended. The slash “/” is printed just before the last digit.

1	2	3	4	5	6	7	8	9	10	11	12	13	14	15	16
P1	D1	D2	D3	D4	D5	D6	D7	D8	D9	U1	U2	S1	S2	CR	LF

11.3.2 Description of data

Signs

[P1] (1 character)

P1	Code	Significance
+	2 B H	Data is 0 or positive
-	2 D H	Data is negative

Numeric value of weighing value

[D 1 to D7(D 8)] (7 or 8 characters)

D 1 to D 8	Code	Significance
0 - 9	30 H – 39 H	Data 0 to 9
.	2 EH	Decimal point, position not fixed
SP	20 H	Space character, leading zero suppressed
/	2FH	Non verified value separated by „/“ (only with menu setting [A. PrF. 3])

Units

[U 1, U 2] 2 digits

U1	U2	ASCII code		Significance	Display
(SP)	G	20H	47H	Gram	g
C	T	43H	54H	Carat	ct
O	Z	4FH	5AH	Ounce	oz
L	B	4CH	42H	Pound	lb
O	T	4FH	54H	Troy ounce	oz t
D	W	44H	57H	Pennyweight	dwt
G	R	4BH	52H	Grain	▶ Bottom right
T	L	54H	4CH	Tael (Hong Kong)	tl
T	L	54H	4CH	Tael (Singapore, Malaysia)	[tl ▶ Upper right]
T	L	54H	4CH	Tael (Taiwan)	[tl ▶ Bottom right]
M	O	4DH	4FH	Momme	(mom)
t	o	74H	6FH	Tola	to
(SP)	%	20H	25H	Percent determination	%
P	C	50H	43H	Parts counting	Pcs

Tolerance weighing

[S1] (1 character)

S 2	Code	Significance	Remarks
L	4CH	Load below specified tolerance	1- or 2 end points
G	47H	Load within specified tolerance	
H	48H	Goods to be weighed above tolerance limit	
(SP)	20 H	No evaluation result / space character	

Data status

[S2] (1 character)

S 2	Code	Significance
S	53 H	Data stabilized *
U	55 H	Data not stabilized (fluctuating) *
E	45 H	Data error, all data apart from S 2 not allowed. Balance indicating error (o-Err, u-Err)
(SP)	20 H	No status / space character

11.3.3 Output examples

Examples 6-digit data format:

- Stable weighing value [3000.1g]

1	2	3	4	5	6	7	8	9	10	11	12	13	14
+	0	3	0	0	0	.	1	(SP)	G	(SP)	S	CR	LF

- Instable weighing value [-10.05 mom]

1	2	3	4	5	6	7	8	9	10	11	12	13	14
-	0	0	1	0	.	0	5	M	O	(SP)	U	CR	LF

Examples 7-digit data format:

- Stable weighing value [3000.1g]

1	2	3	4	5	6	7	8	9	10	11	12	13	14	15
+	0	0	3	0	0		.	1	(SP)	G	(SP)	S	CR	LF

- Instable weighing value [-10.05 mom]

1	2	3	4	5	6	7	8	9	10	11	12	13	14	15
-	0	0	0	1	0	.	0	5	M	O	(SP)	U	CR	LF

11.4 Remote control instructions

General order format:

Consisting of 4 characters including the terminators (CR, LF).

C1	C2	CR	LF
----	----	----	----

Subsequent commands will be detected by the weighing scale.

1. Data output

C1	C2	Code (C1)	Code (C2)	Function	Response
O	0	4FH	30H	No data output	A00: Free from error E01: Error message
O	1	4FH	31H	Continuous data output	
O	2	4FH	32H	Continuous data output stable weighing values	
O	3	4FH	33H	Output for stable and instable weighing values after pressing PRINT key	
O	4	4FH	34H	Output for stable weighing value after previous relief of balance	
O	5	4FH	35H	One output for stable weighing value. No output for stable weighing values. Renewed output after stabilization	
O	6	4FH	36H	One output for stable weighing value. Continuous output for instable weighing values.	
O	7	4FH	37H	Output of stable weighing values after pressing PRINT key	
O	8	4FH	38H	Single immediate output	
O	9	4FH	39H	Single output after stabilization	

2. Taring / Setting to zero

C1	C2	Code (C1)	Code (C2)	Function	Response
T	(SP)	54H	20H	Taring (>1,5 % Max) Zero setting (< 1,5 % Max)	A00: Free from error E01: Error message
T	1	54H	31H	Taring	A00: Free from error E01: Error message E04: Taring range exceeded
Z	(SP)	5AH	20H	Zeroing	A00: Free from error E01: Error message E04: Zero range exceeded

3. Internal adjustment

C1	C2	Code (C1)	Code (C2)	Function	Response
C	1	43H	31H	Carry out internal adjustment	A00: Free from error E01: Error message E02: Order cannot be carried out

4. Query date / time

C1	C2	Code (C1)	Code (C2)	Function	Response
D	D	44H	44H	Query date	DATE : d d . m m . y y y y (CR, LF) Date format depends on menu setting [b.dat.], see chap. 8.1.2
D	T	44H	%4H	Query time	TIME:(SP) (SP) (SP) (SP) (SP) h h : m m (CR, LF)

12 Servicing, maintenance, disposal



Before any maintenance, cleaning and repair work disconnect the appliance from the operating voltage.

12.1 Cleaning

Please do not use aggressive cleaning agents (solvents or similar agents), but a cloth dampened with mild soap suds. Ensure that no liquid penetrates into the device. Polish with a dry soft cloth.

Loose residue sample/powder can be removed carefully with a brush or manual vacuum cleaner.

Spilled weighing goods must be removed immediately.

12.2 Servicing, maintenance

- ⇒ The appliance may only be opened by trained service technicians who are authorized by KERN.
- ⇒ Before opening, disconnect from power supply.

12.3 Disposal

Disposal of packaging and appliance must be carried out by operator according to valid national or regional law of the location where the appliance is used.

13 Instant help

In case of an error in the program process, briefly turn off the balance and disconnect from power supply. The weighing process must then be restarted from the beginning.

Help:

Fault

Possible cause

The displayed weight does not glow.

- The balance is not switched on.
- The mains supply connection has been interrupted (mains cable not plugged in/faulty).
- Power supply interrupted.

The displayed weight is permanently changing

- Draught/air movement
- Table/floor vibrations
- Weighing pan has contact with other objects.
- Electromagnetic fields / static charging (choose different location/switch off interfering device if possible)

The weighing result is obviously incorrect

- The display of the balance is not at zero
- Adjustment is no longer correct.
- The balance is on an uneven surface.
- Great fluctuations in temperature.
- Warm-up time was ignored.
- Electromagnetic fields / static charging (choose different location/switch off interfering device if possible)

14 Error messages

Error message	Possible cause
<i>o-Err</i>	Weighing range exceeded
<i>u-Err</i>	Insufficient preload, e. g. missing weighing pan
<i>1-Err</i>	Wrong adjustment weight (< 50% max)
<i>2-Err</i>	Divergence last external adjustment > 1%
<i>3-Err</i>	Weighing pan loaded during adjustment
<i>4-Err</i>	Divergence from last internal adjustment > 1%
<i>A-Err</i>	Internal adjustment automatics defective
<i>b-Err</i>	Check ambient conditions (static charges, vibration, etc.)
<i>C-Err</i>	Internal clock defective
<i>d-Err</i>	Damaged electronics
<i>L-Err</i>	Placed weight too light, e.g. for reference calculation during parts counting or percentage determination
<i>Err 710</i>	Instable environmental conditions

Should other error messages occur, switch balance off and then on again. If the error message remains inform manufacturer.

15 Declaration of conformity

To view the current EC/EU Declaration of Conformity go to:

www.kern-sohn.com/ce

- i** The scope of delivery for verified weighing balances (= conformity-rated weighing balances) includes a Declaration of Conformity.